

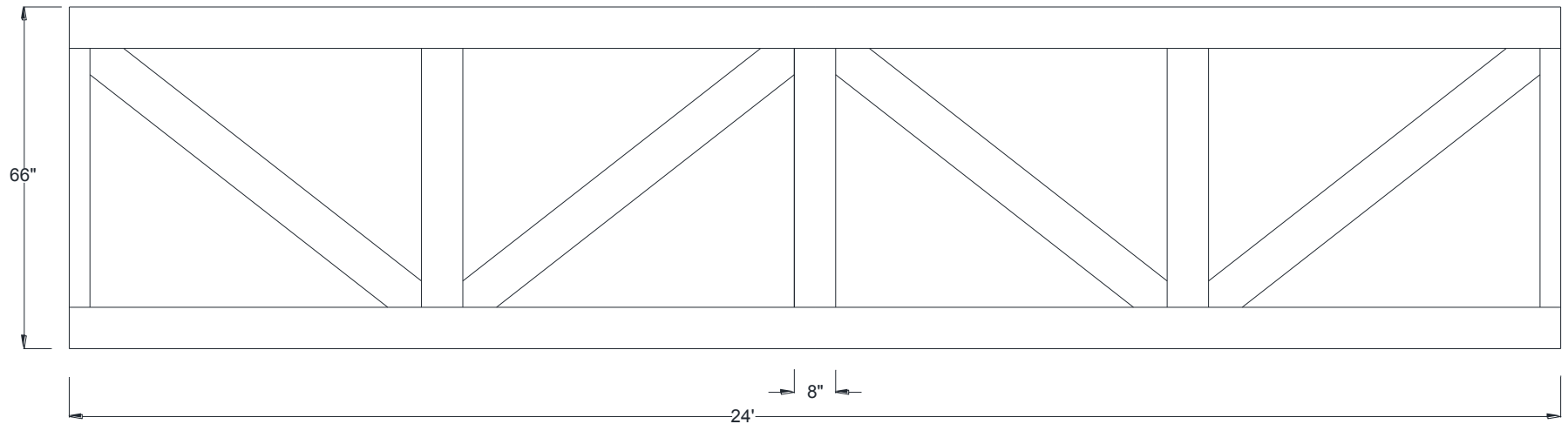

## Flat Truss

288" Width

Shown: 66" Height



Volterra Architectural Products LLC – 1902 North 22nd Avenue – Phoenix, AZ 85009 – 602.258.7373

[www.volterraproducts.com](http://www.volterraproducts.com)

# Flat Truss

## 288" Width

### Dimension Sheet

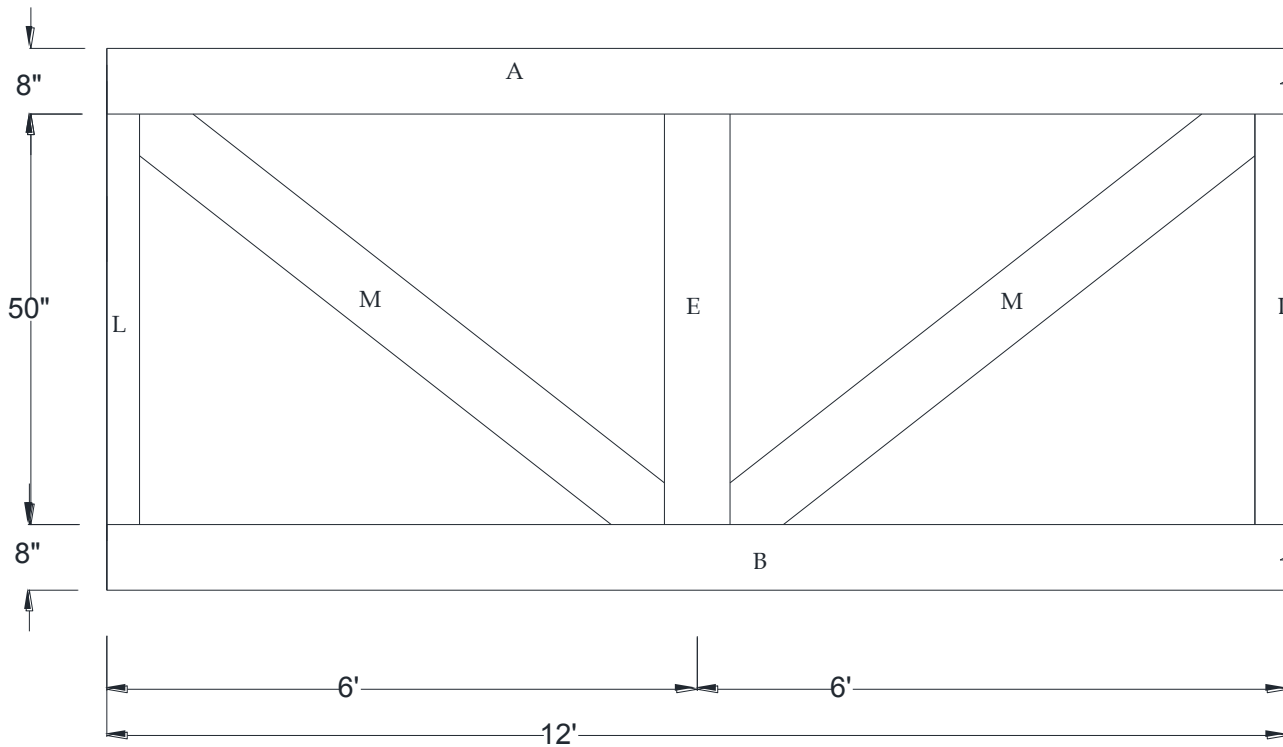

#### Specifications

A) Rafter/Top Chord:	8" x 8"
B) Bottom/Tie Chord:	8" x 8"
C) Upper/Tie Chord:	N/A
D) King Post:	8" x 8"
E) Queen Post:	8" x 8"
F) Jack Post:	N/A
G) Hammer Beam Top:	N/A
H) Hammer Beam Btm:	N/A
I) Collar Brace Upper:	N/A
J) Collar Brace Lower:	N/A
K) Hammer Brace:	N/A
L) Wall Post:	8" x 4"
M) Web 1:	8" x 8"
N) Web 2:	N/A
O) Web 3:	N/A
P) Flying Buttress:	N/A
Q) Newel End:	N/A



## Flat Truss Recommended Interior Installation Procedures

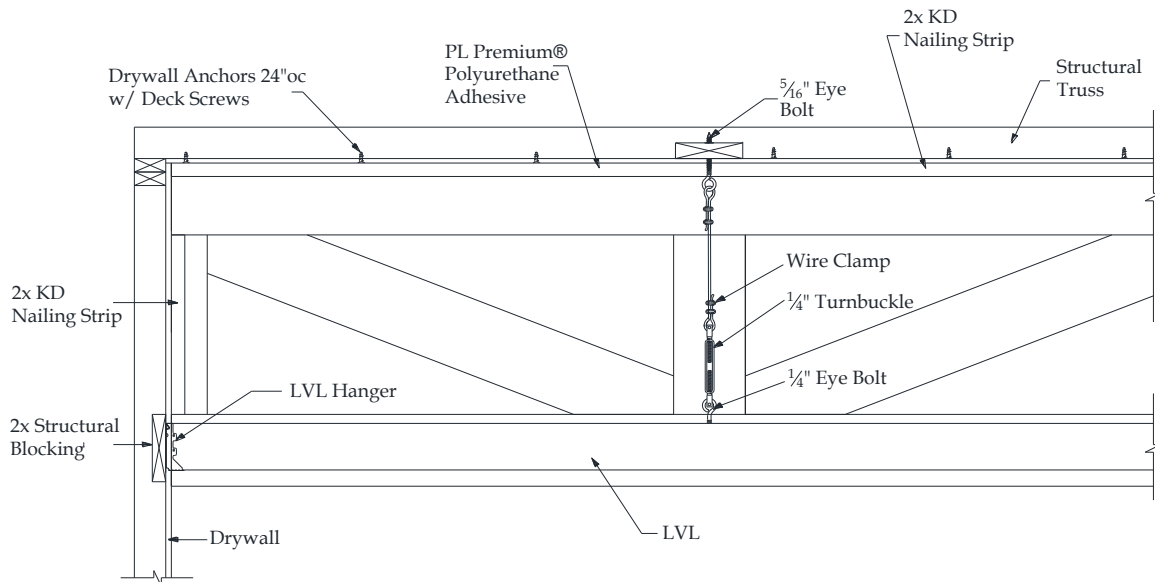

**A:** Layout beams and chalk lines to the inside of top chord.

**B:** Screw in threaded eye bolts into structural blocking at all points. Flat trusses may require cabling through king, queen and jack posts depending on bottom chord height and span of truss.

**C:** Place KD nailing strip on chalk line and pre-drill  $\frac{1}{8}$ " holes 24" on center through strip and into drywall. Install drywall anchors into predrilled holes. Apply  $\frac{1}{4}$ " bead of PL adhesive to top of nailing strip and install using deck screws.

**D:** Measure, cut and dry fit top chord then pull beam down. Apply PL adhesive to sides of nailing strips. Install top chord and use trim screws to secure 24" on center.

**E:** Cut 3"-4" diameter round hole for king/queen/jack post turnbuckles.

**F:** Measure correct length and cut braided cable and install turnbuckle kits. Stain raw foam on all posts and the loose side. Install all posts and the 4th side.

**G:** Install LVL Hanger directly to structural blocking. Attach turnbuckles to bottom chord.

**H:** Add 2X blocking every 24"OC to LVL so bottom chord beam is a tight fit. Dry fit bottom chord before installing. Apply PL adhesive to blocking and install bottom chord and its 4th side.

**I:** Measure, cut and dry fit wall post and webbing. Glue and toe screw wall posts and webbing into connecting beams.

**J:** Patch holes and touch up HDF if necessary.

Volterra Architectural Products LLC – 1902 North 22nd Avenue – Phoenix , AZ 85009 – 602.258.7373

[www.volterraproducts.com](http://www.volterraproducts.com)