

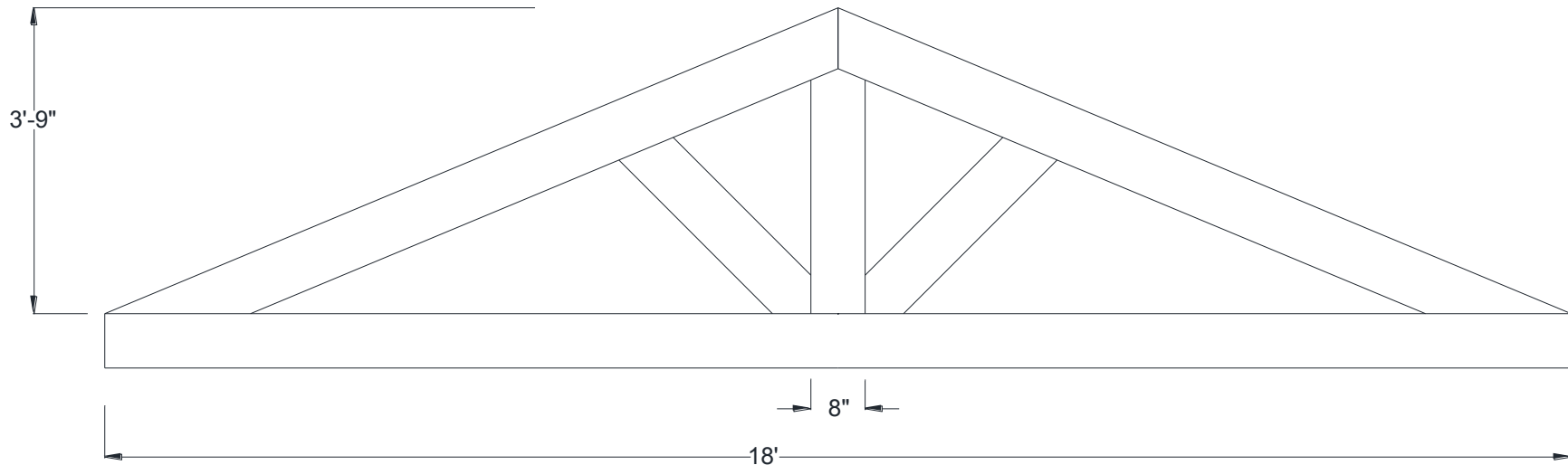

Huntsman Hammered Truss

216" Width

Shown: 5/12 Pitch



Volterra Architectural Products LLC – 1902 North 22nd Avenue – Phoenix, AZ 85009 – 602.258.7373

www.volterraproducts.com

Huntsman Hammered Truss

216" Width

Dimension Sheet

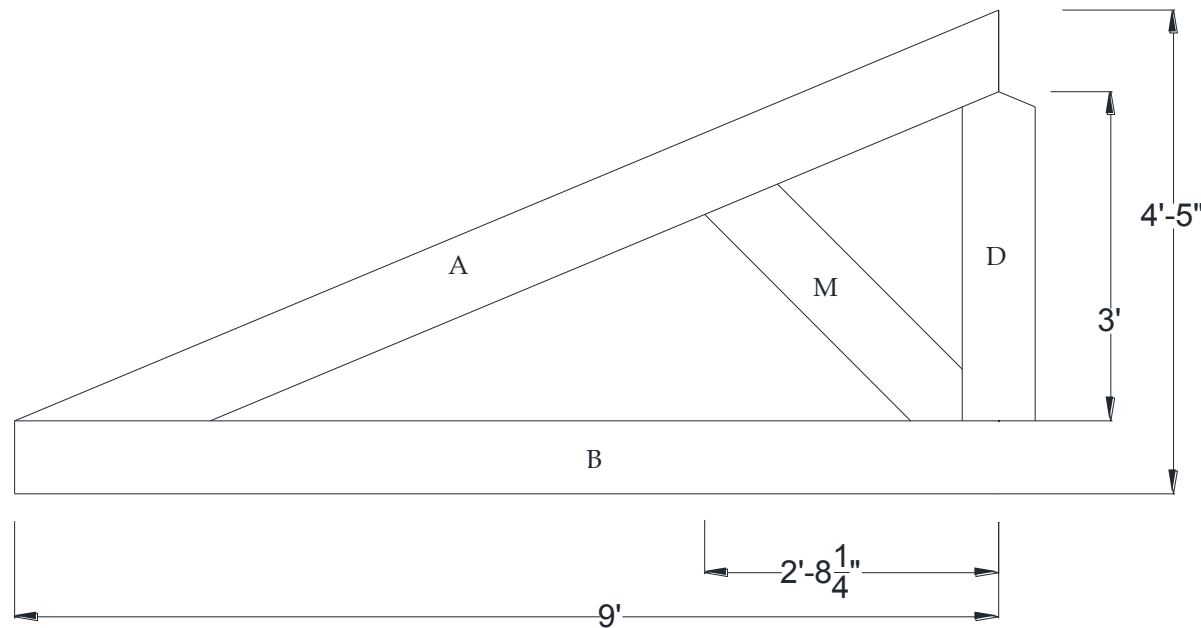

Specifications

Pitch:	5/12
A) Rafter/Top Chord:	8" x 8"
B) Bottom/Tie Chord:	8" x 8"
C) Upper/Tie Chord:	N/A
D) King Post:	8" x 8"
E) Queen Post:	N/A
F) Jack Post:	N/A
G) Hammer Beam Top:	N/A
H) Hammer Beam Btm:	N/A
I) Collar Brace Upper:	N/A
J) Collar Brace Lower:	N/A
K) Hammer Brace:	N/A
L) Wall Post:	N/A
M) Web 1:	8" x 8"
N) Web 2:	N/A
O) Web 3:	N/A
P) Flying Buttress:	N/A
Q) Newel End:	N/A



Huntsman Truss Recommended Interior Installation Procedures

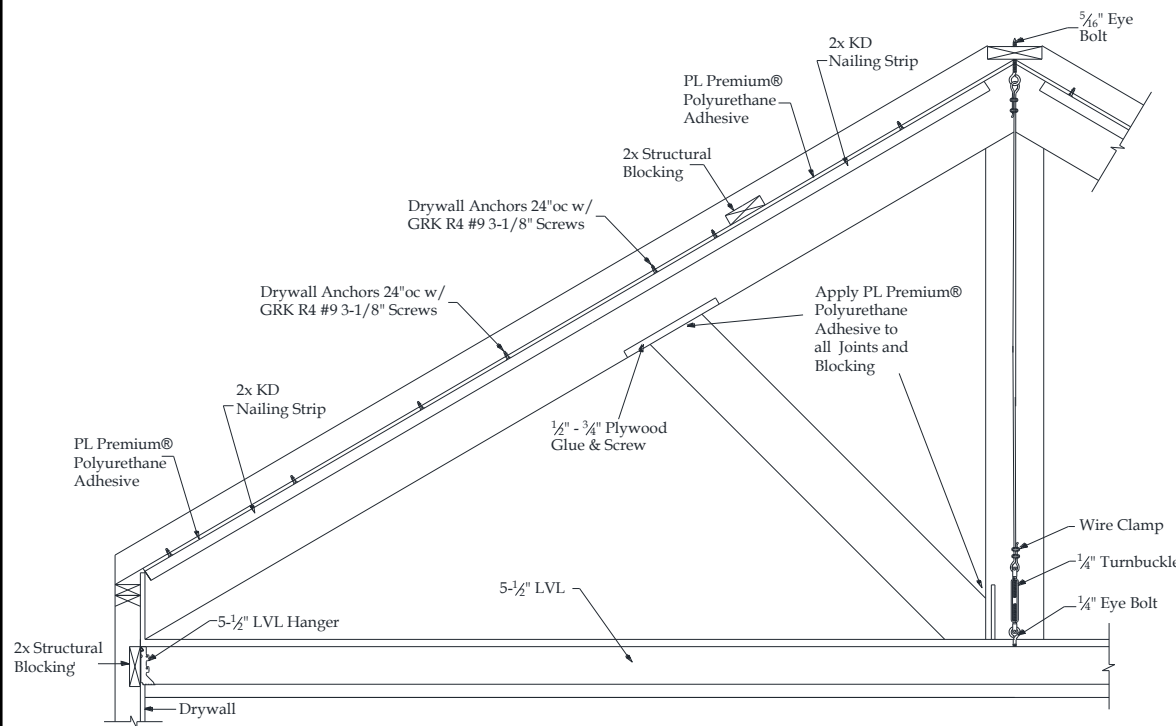

- A:** Layout beams and chalk lines to the inside of rafter beam.
- B:** Measure down ridge and screw eye bolts into structural blocking at all points.
- C:** Place KD nailing strip on chalk line and pre-drill $\frac{1}{8}$ " holes 24" on center through strip and into drywall. Install drywall anchors into predrilled holes. Apply $\frac{1}{4}$ " bead of PL adhesive to top of nailing strip and install using deck screws.
- D:** Glue and screw $\frac{3}{4}$ " plywood screw plate for web beam install to inside of rafter beam.
- E:** Measure, cut and dry fit rafter beam then pull beam down. Apply PL adhesive to sides of nailing strips. Install rafter beam and use finish screws to secure 24" on center.
- F:** Cut 3"-4" diameter round hole into the bottom of rafter beam for king/queen posts turnbuckle.
- G:** Measure correct length and cut braided cable and install turnbuckle kit.
- H:** Install LVL hangers directly to structural blocking.
- I:** Add 2X blocking every 24" OC to LVL so bottom chord beam is a tight fit. Install LVL. Install bottom chord and its 4th side
- J:** Glue and screw off $\frac{3}{4}$ " plywood screw plate to inside of king post for connection of web. Stain raw foam on king posts loose side. Install king posts and its 4th side.
- K:** Measure, cut and dry fit web beam. Glue and toe screw in place. Patch holes and touch up HDF if necessary.

Volterra Architectural Products LLC – 1902 North 22nd Avenue – Phoenix , AZ 85009 – 602.258.7373

www.volterraproducts.com