

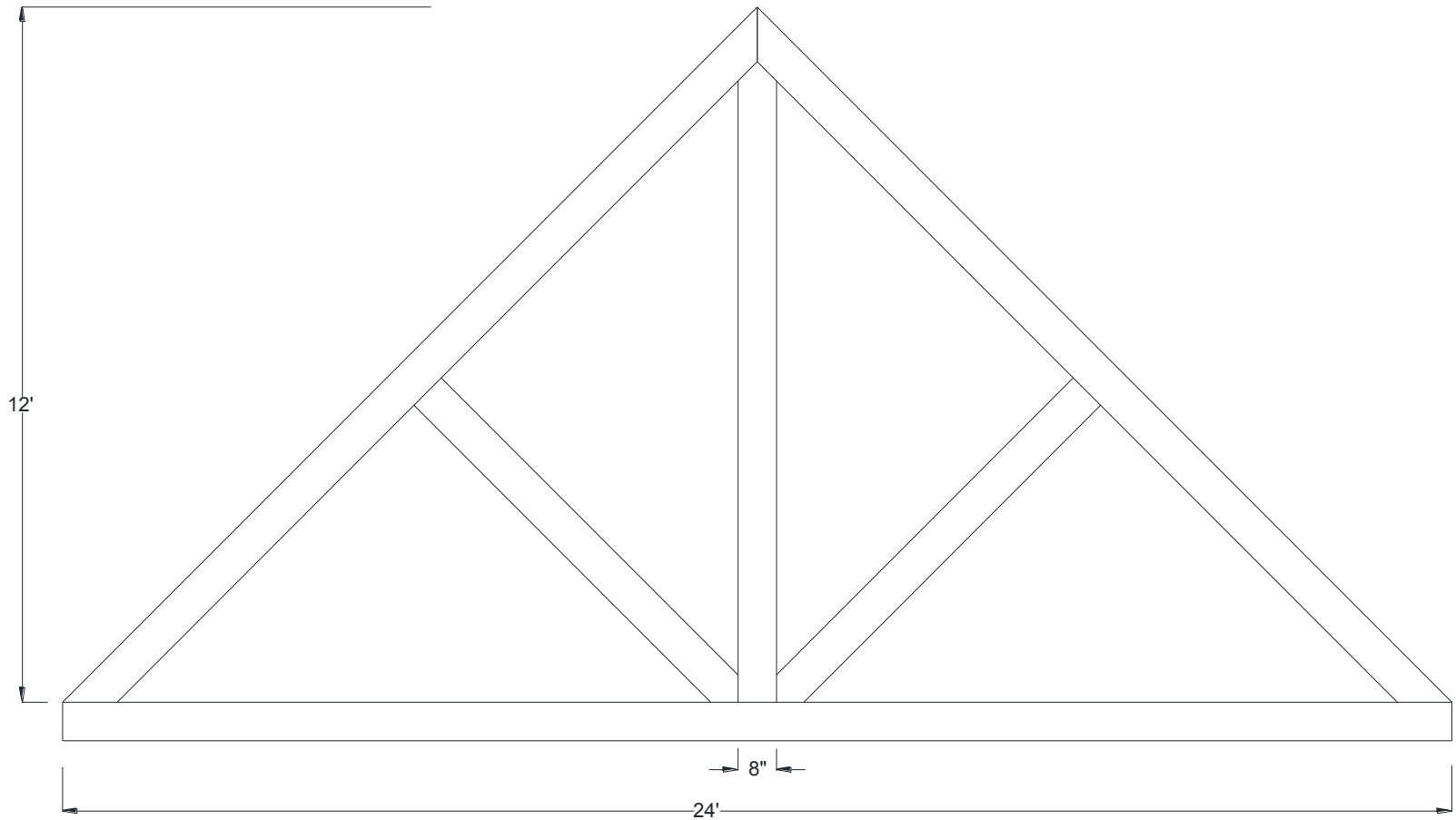

Huntsman Hammered Truss

288" Width

Shown: 12/12 Pitch



Volterra Architectural Products LLC – 1902 North 22nd Avenue – Phoenix, AZ 85009 – 602.258.7373

www.volterraproducts.com

Huntsman Hammered Truss

288" Width

Dimension Sheet

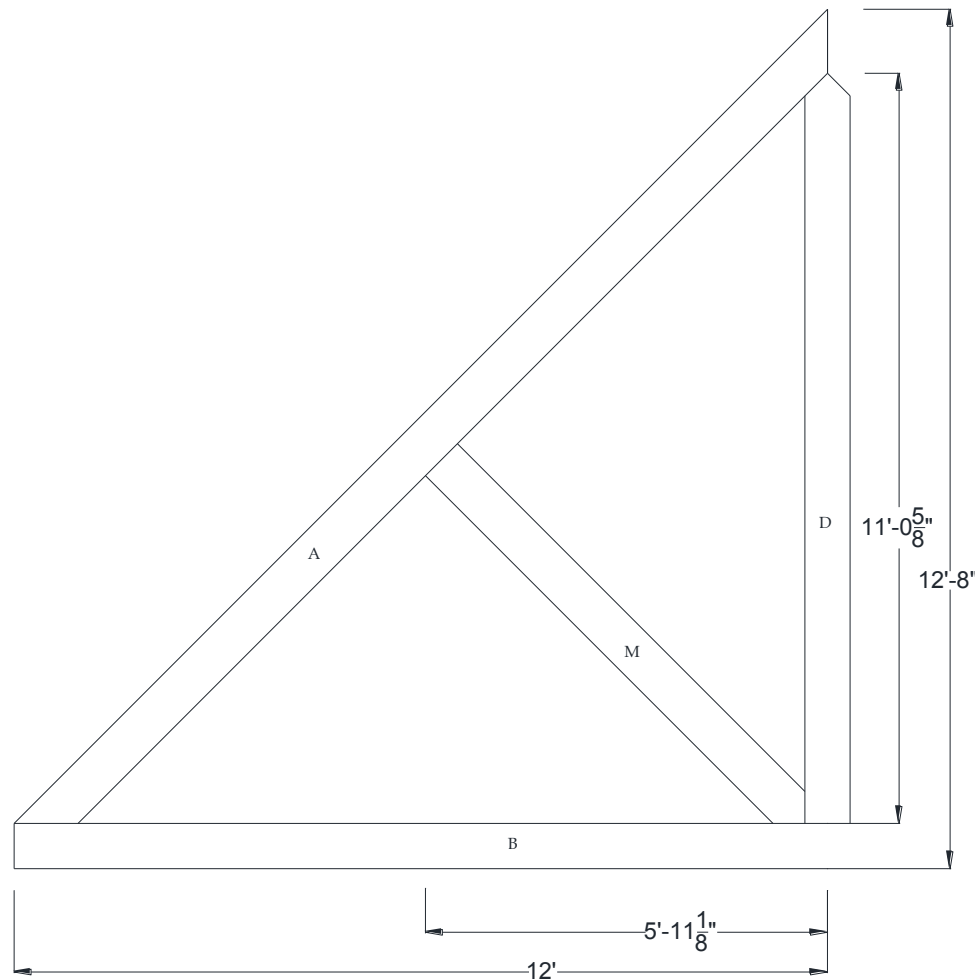

Specifications

| | |
|------------------------|---------|
| Pitch: | 12/12 |
| A) Rafter/Top Chord: | 8" x 8" |
| B) Bottom/Tie Chord: | 8" x 8" |
| C) Upper/Tie Chord: | N/A |
| D) King Post: | 8" x 8" |
| E) Queen Post: | N/A |
| F) Jack Post: | N/A |
| G) Hammer Beam Top: | N/A |
| H) Hammer Beam Btm: | N/A |
| I) Collar Brace Upper: | N/A |
| J) Collar Brace Lower: | N/A |
| K) Hammer Brace: | N/A |
| L) Wall Post: | N/A |
| M) Web 1: | 8" x 8" |
| N) Web 2: | N/A |
| O) Web 3: | N/A |
| P) Flying Buttress: | N/A |
| Q) Newel End: | N/A |



Huntsman Truss Recommended Interior Installation Procedures

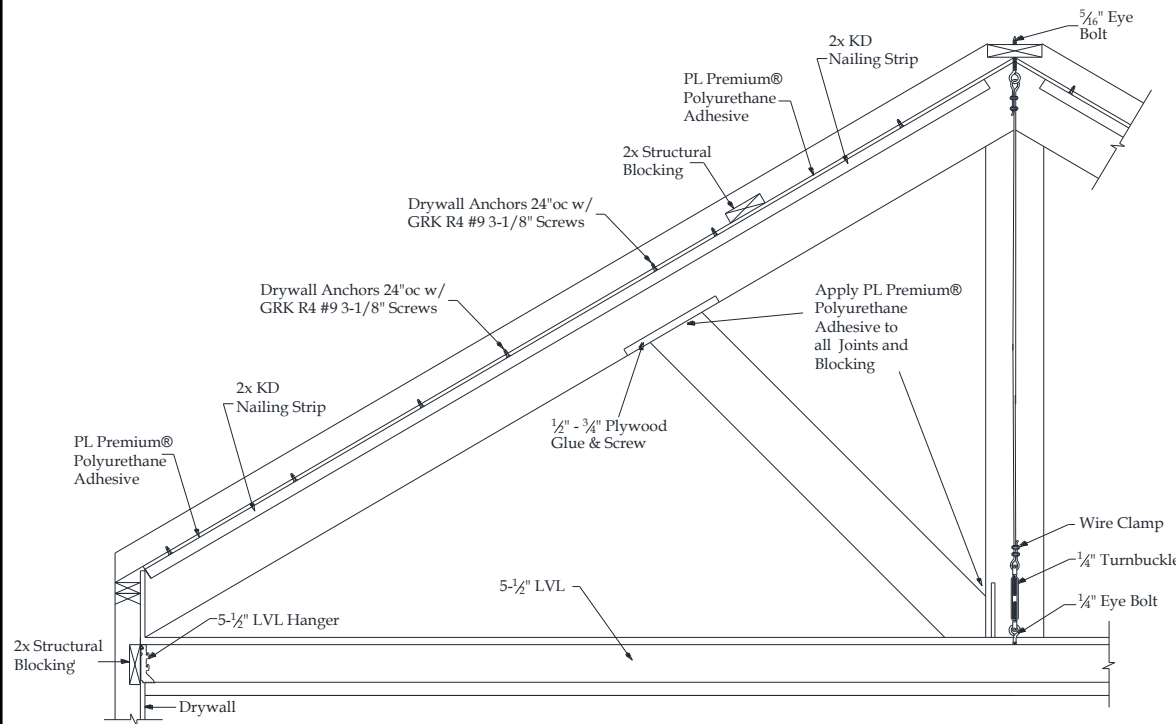

- A:** Layout beams and chalk lines to the inside of rafter beam.
- B:** Measure down ridge and screw eye bolts into structural blocking at all points.
- C:** Place KD nailing strip on chalk line and pre-drill $\frac{1}{8}$ " holes 24" on center through strip and into drywall. Install drywall anchors into predrilled holes. Apply $\frac{1}{4}$ " bead of PL adhesive to top of nailing strip and install using deck screws.
- D:** Glue and screw $\frac{3}{4}$ " plywood screw plate for web beam install to inside of rafter beam.
- E:** Measure, cut and dry fit rafter beam then pull beam down. Apply PL adhesive to sides of nailing strips. Install rafter beam and use finish screws to secure 24" on center.
- F:** Cut 3"-4" diameter round hole into the bottom of rafter beam for king/queen posts turnbuckle.
- G:** Measure correct length and cut braided cable and install turnbuckle kit.
- H:** Install LVL hangers directly to structural blocking.
- I:** Add 2X blocking every 24" OC to LVL so bottom chord beam is a tight fit. Install LVL. Install bottom chord and its 4th side
- J:** Glue and screw off $\frac{3}{4}$ " plywood screw plate to inside of king post for connection of web. Stain raw foam on king posts loose side. Install king posts and its 4th side.
- K:** Measure, cut and dry fit web beam. Glue and toe screw in place. Patch holes and touch up HDF if necessary.

Volterra Architectural Products LLC – 1902 North 22nd Avenue – Phoenix , AZ 85009 – 602.258.7373

www.volterraproducts.com