

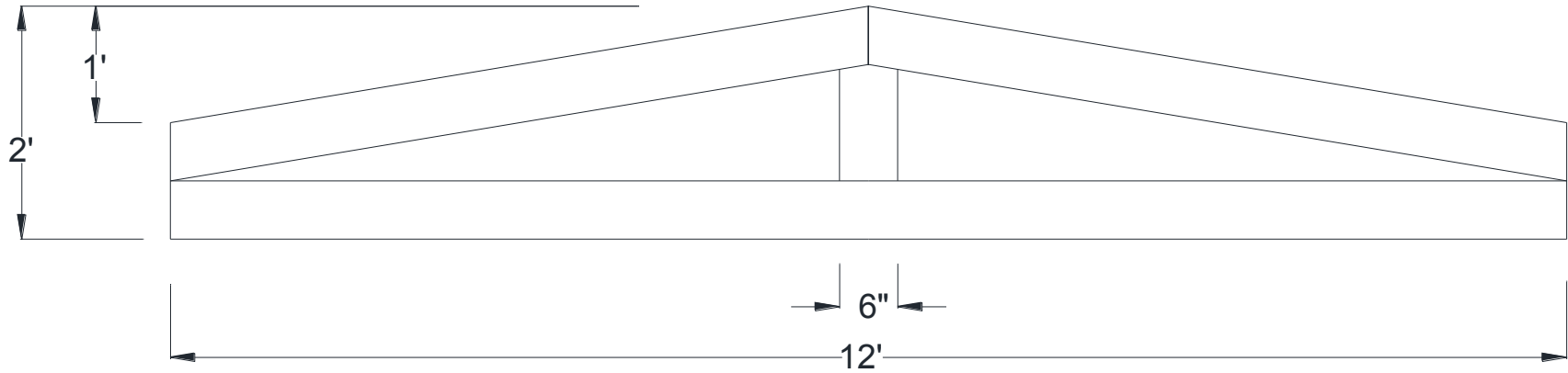

King Truss
144" Width
Shown: 2/12 Pitch



Volterra Architectural Products LLC – 1902 North 22nd Avenue – Phoenix, AZ 85009 – 602.258.7373

www.volterraproducts.com

King Truss

144" Width

Dimension Sheet

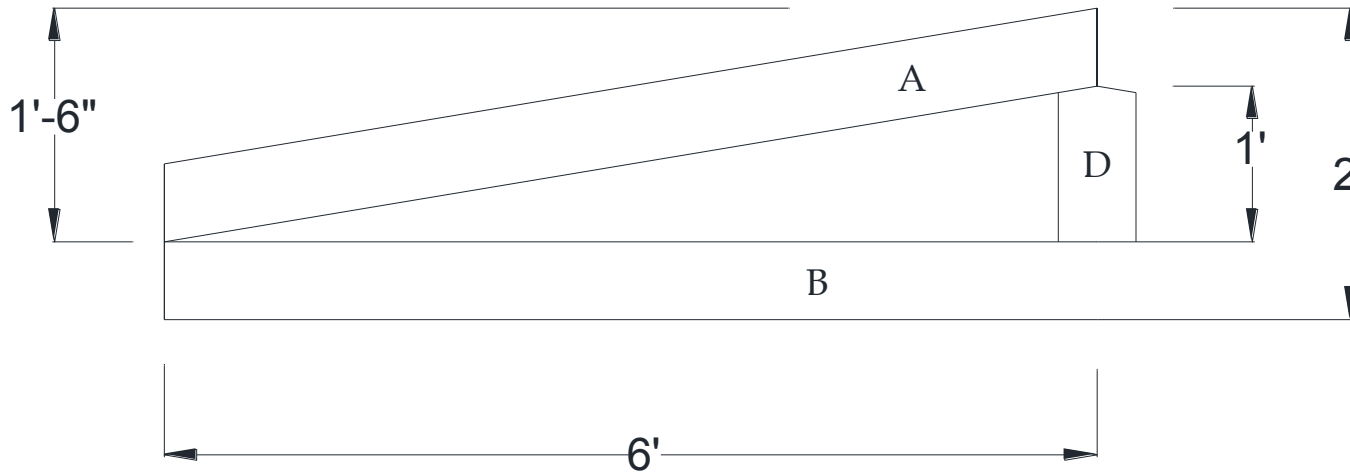

Specifications

Pitch:	2/12
A) Rafter/Top Chord:	6" x 6"
B) Bottom/Tie Chord:	6" x 6"
C) Upper/Tie Chord:	N/A
D) King Post:	6" x 6"
E) Queen Post:	N/A
F) Jack Post:	N/A
G) Hammer Beam Top:	N/A
H) Hammer Beam Btm:	N/A
I) Collar Brace Upper:	N/A
J) Collar Brace Lower:	N/A
K) Hammer Brace:	N/A
L) Wall Post:	N/A
M) Web 1:	N/A
N) Web 2:	N/A
O) Web 3:	N/A
P) Flying Buttress:	N/A
Q) Newel End:	N/A



King Truss Recommended Interior Installation Procedures

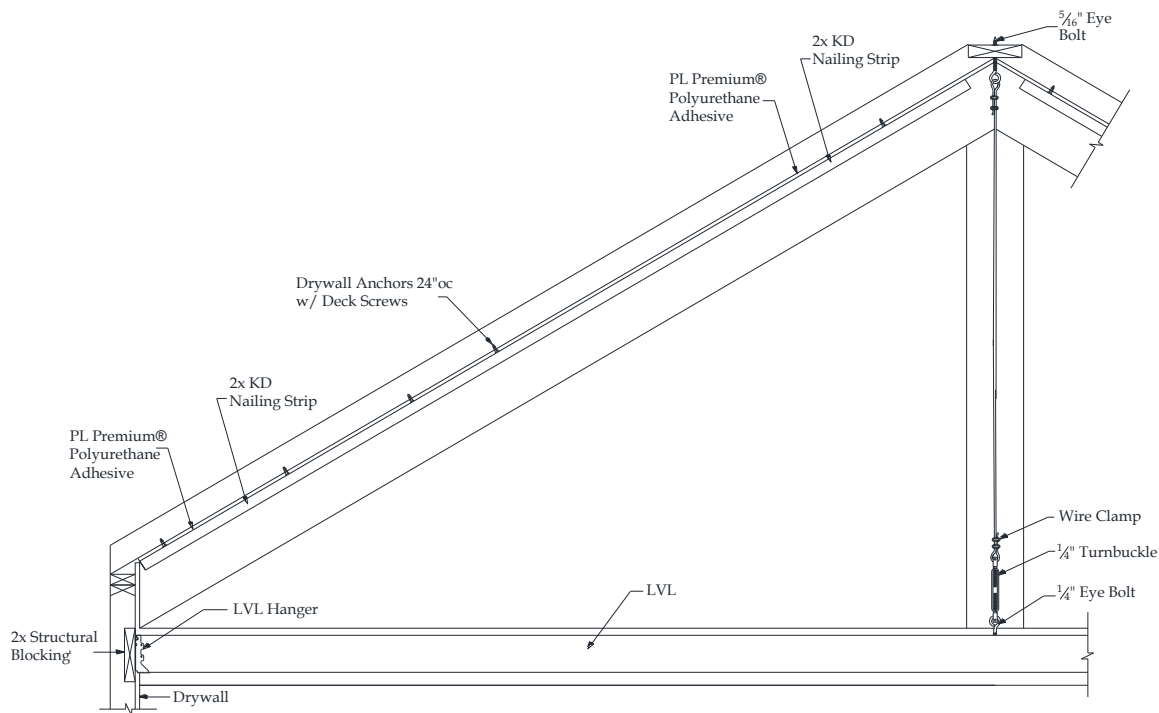

- A:** Layout beams and chalk lines to the inside of rafter beam.
- B:** Screw eye bolts into structural blocking at all points.
- C:** Place KD nailing strip on chalk line and pre-drill $\frac{1}{8}$ " holes 24" on center through strip and into drywall. Install drywall anchors into predrilled holes. Apply $\frac{1}{4}$ " bead of PL adhesive to top of nailing strip and install using deck screws.
- D:** Measure, cut and dry fit rafter beam then pull beam down. Apply PL adhesive to sides of nailing strips. Install rafter beam and use finish screws to secure 24" on center.
- E:** Cut 3"-4" diameter round hole into the bottom of rafter beam for king post turnbuckle.
- F:** Measure correct length and cut braided cable and install turnbuckle kit.
- G:** Install LVL hangers directly to structural blocking.
- H:** Add 2X blocking every 24"OC to LVL so bottom chord beam is a tight fit. Install LVL. Dry fit bottom chord before installing. Apply PL adhesive to blocking and install bottom chord and its 4th side.
- H:** Stain raw foam on king posts and its loose side. Install king post and its 4th side.
- I:** Patch holes and touch up HDF if necessary.

Volterra Architectural Products LLC – 1902 North 22nd Avenue – Phoenix , AZ 85009 – 602.258.7373

www.volterraproducts.com