

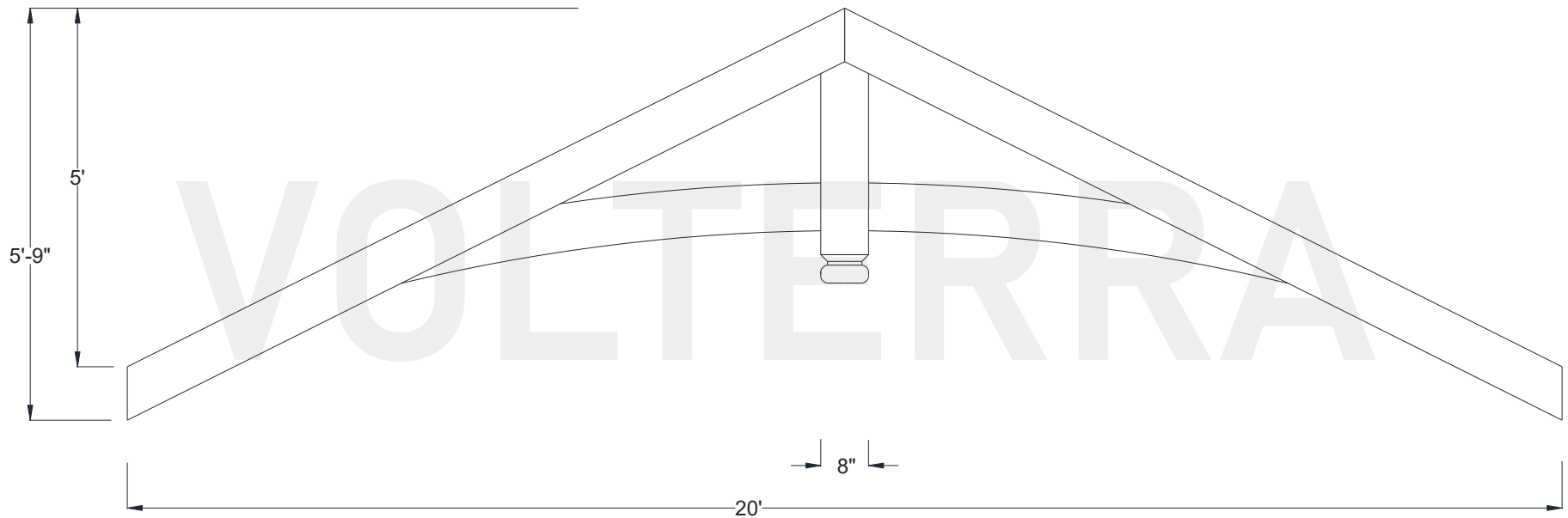

Arched King Truss

240" Width

Shown: 6/12 Pitch



Volterra Architectural Products LLC – 1902 North 22nd Avenue – Phoenix, AZ 85009 – 602.258.7373

www.volterraproducts.com

Arched King Truss

240" Width

Dimension Sheet

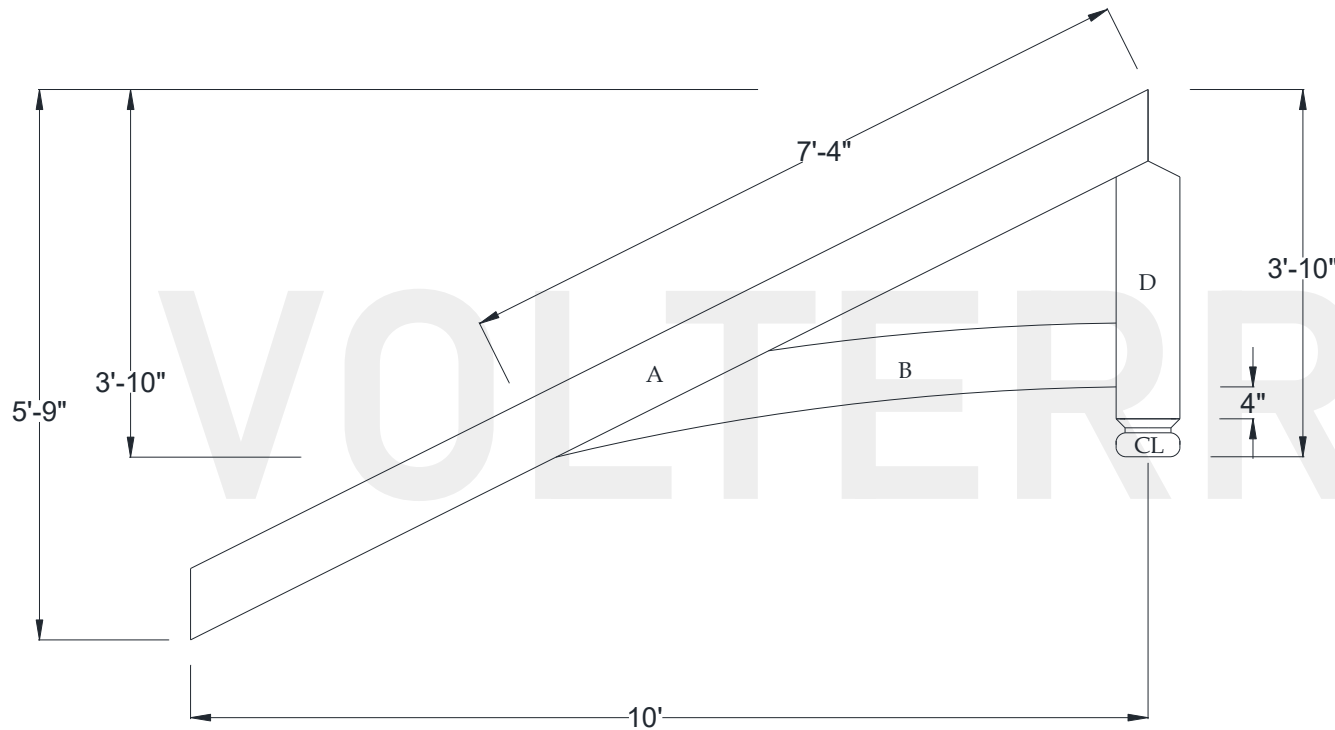

Specifications

Pitch:	6/12
A) Rafter/Top Chord:	8" x 8"
B) Bottom/Tie Chord:	8" x 8"
C) Upper/Tie Chord:	N/A
D) King Post:	8" x 8"
E) Queen Post:	N/A
F) Jack Post:	N/A
G) Hammer Beam Top:	N/A
H) Hammer Beam Btm:	N/A
I) Collar Brace Upper:	N/A
J) Collar Brace Lower:	N/A
K) Hammer Brace:	N/A
L) Wall Post:	N/A
M) Web 1:	N/A
N) Web 2:	N/A
O) Web 3:	N/A
P) Flying Buttress:	N/A
Q) Newel End:	CL



Arched King Truss Recommended Interior Installation Procedures

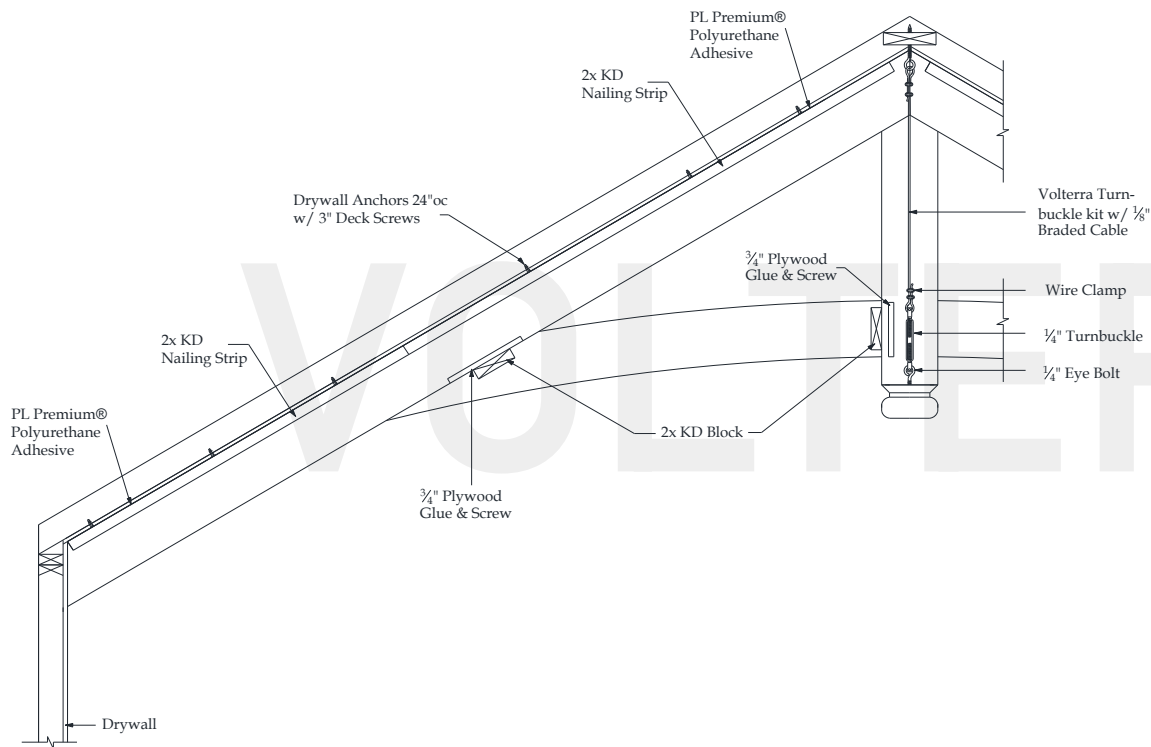

A: Layout beams and chalk lines to the inside of rafter beam.

B: Screw eye bolts into structural blocking at all points.

C: Place KD nailing strip on chalk line and pre-drill $\frac{1}{8}$ " holes 24" on center through strip and into drywall. Install drywall anchors into predrilled holes. Apply $\frac{1}{4}$ " bead of PI adhesive to top of nailing strip and install using deck screws.

D: Glue and screw $\frac{3}{4}$ " plywood screw plate for arched bottom chord install to inside of rafter beam.

E: Measure, cut and dry fit rafter beam then pull beam down. Apply PL adhesive to sides of nailing strips. Install rafter beam and use finish screws to secure 24" on center.

F: Cut 3"-4" diameter round hole into the bottom of rafter beam for king post turnbuckle.

G: Measure correct length and cut braided cable and install turnbuckle kit.

H: Glue and screw off $\frac{3}{4}$ " plywood screw plate to inside of king post for connection of arched bottom chord. Stain raw foam on king posts loose side. Install king post and its 4th side.

I: Cut and add blocking to king post for arched bottom chord attachment. Measure, cut and dry fit arched bottom chord. Cut and add 2x block to inside of bottom chord at rafter connection.

J: Install arched bottom chord beam. Glue and toe screw in place. Patch holes and touch up HDF if necessary.

Volterra Architectural Products LLC – 1902 North 22nd Avenue – Phoenix , AZ 85009 – 602.258.7373

www.volterraproducts.com