

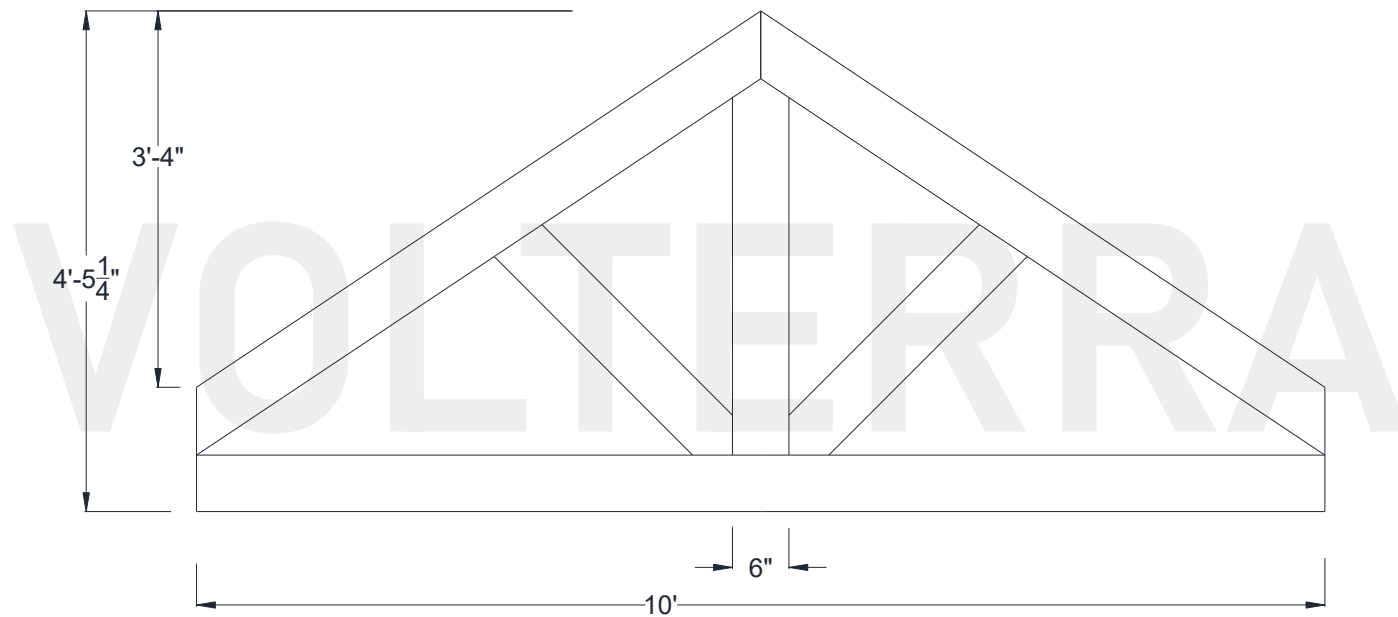

# Huntsman Hammered Truss

120" Width

8/12 Pitch



Volterra Architectural Products LLC — 1902 North 22nd Avenue — Phoenix , AZ 85009 — 602.258.7373

[www.volterraproducts.com](http://www.volterraproducts.com)

# Huntsman Hammered Truss

120" Width

## Dimension Sheet

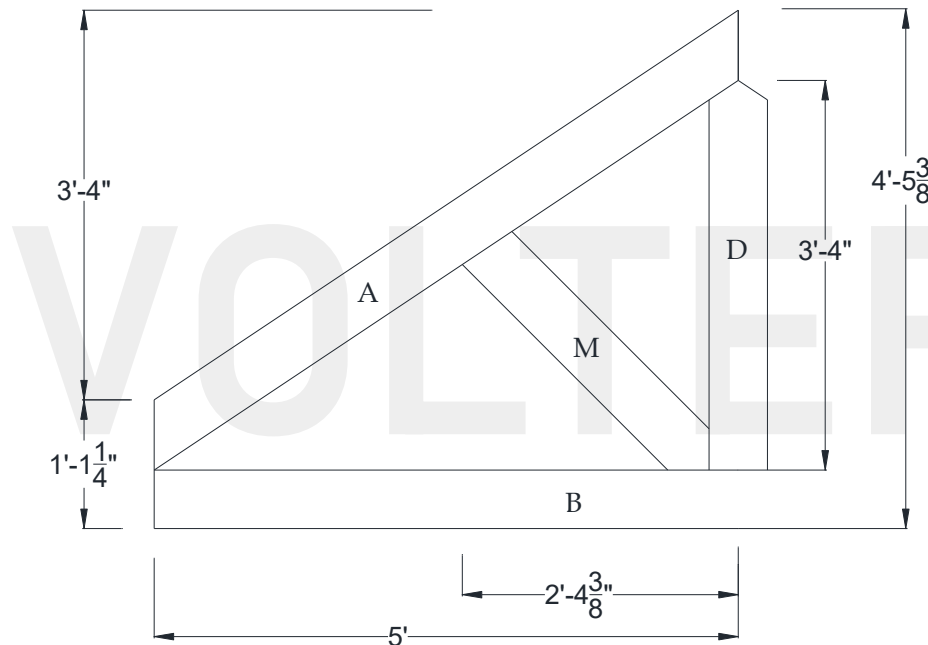

### Specifications

Pitch:	8/12
A) Rafter/Top Chord:	6" x 6"
B) Bottom/Tie Chord:	6" x 6"
C) Upper/Tie Chord:	N/A
D) King Post:	6" x 6"
E) Queen Post:	N/A
F) Jack Post:	N/A
G) Hammer Beam Top:	N/A
H) Hammer Beam Btm:	N/A
I) Collar Brace Upper:	N/A
J) Collar Brace Lower:	N/A
K) Hammer Brace:	N/A
L) Wall Post:	N/A
M) Web 1:	6" x 6"
N) Web 2:	N/A
O) Web 3:	N/A
P) Flying Buttress:	N/A
Q) Newel End:	N/A



## Huntsman Truss Recommended Interior Installation Procedures

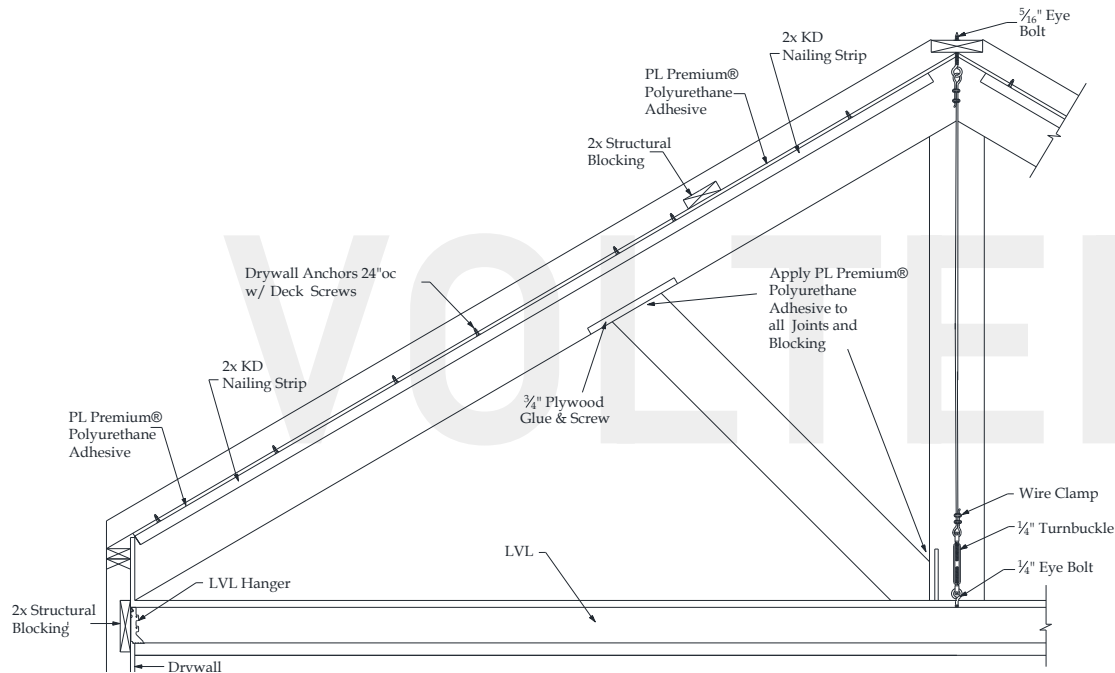

**A:** Layout beams and chalk lines to the inside of rafter beam.

**B:** Screw eye bolts into structural blocking at all points.

**C:** Place KD nailing strip on chalk line and pre-drill  $\frac{1}{8}$ " holes 24" on center through strip and into drywall. Install drywall anchors into predrilled holes. Apply  $\frac{1}{4}$ " bead of PL adhesive to top of nailing strip and install using deck screws.

**D:** Glue and screw  $\frac{3}{4}$ " plywood screw plate for web beam install to inside of rafter beam.

**E:** Measure, cut and dry fit rafter beam then pull beam down. Apply PL adhesive to sides of nailing strips. Install rafter beam and use finish screws to secure 24" on center.

**F:** Cut 3"-4" diameter round hole into the bottom of rafter beam for king post turnbuckle.

**G:** Measure correct length and cut braided cable and install turnbuckle kit.

**H:** Install LVL hangers directly to structural blocking.

**I:** Add 2X blocking every 24" OC to LVL so bottom chord beam is a tight fit. Install LVL. Install bottom chord and its 4th side. Connect turnbuckle kit to LVL.

**J:** Glue and screw off  $\frac{3}{4}$ " plywood screw plate to inside of king post for connection of arched bottom chord. Stain raw foam on king posts loose side. Install king post and its 4th side.

**K:** Measure, cut and dry fit web beam. Glue and toe screw in place. Patch holes and touch up HDF if necessary.

Volterra Architectural Products LLC – 1902 North 22nd Avenue – Phoenix , AZ 85009 – 602.258.7373

[www.volterraproducts.com](http://www.volterraproducts.com)