

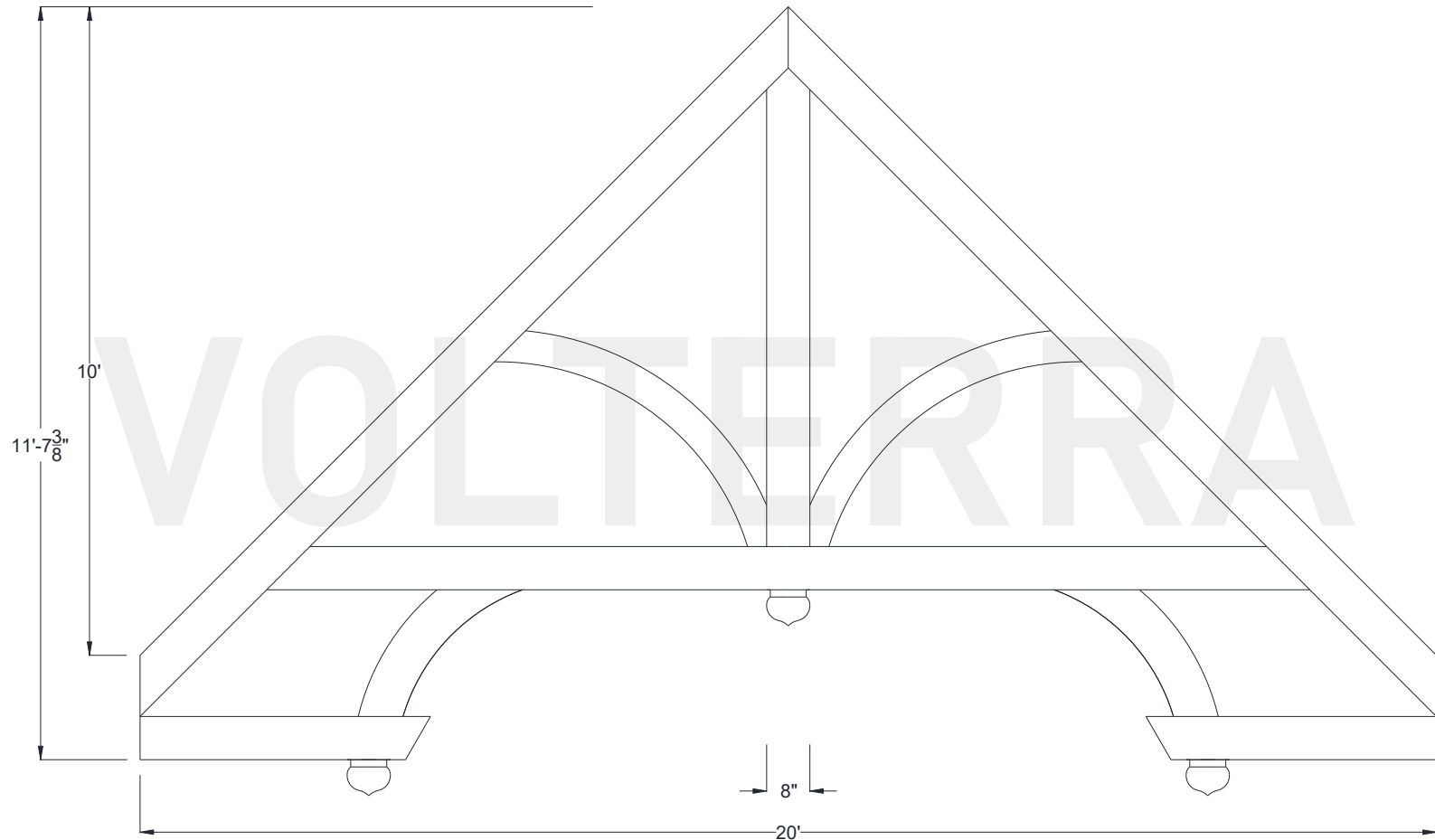

Aspen Hammered Truss

240" width

Shown: 12/12 Pitch



Volterra Architectural Products LLC — 1902 North 22nd Avenue — Phoenix , AZ 85009 — 602.258.7373

www.volterraproducts.com

Aspen Hammered Truss

240" Width

Dimension Sheet

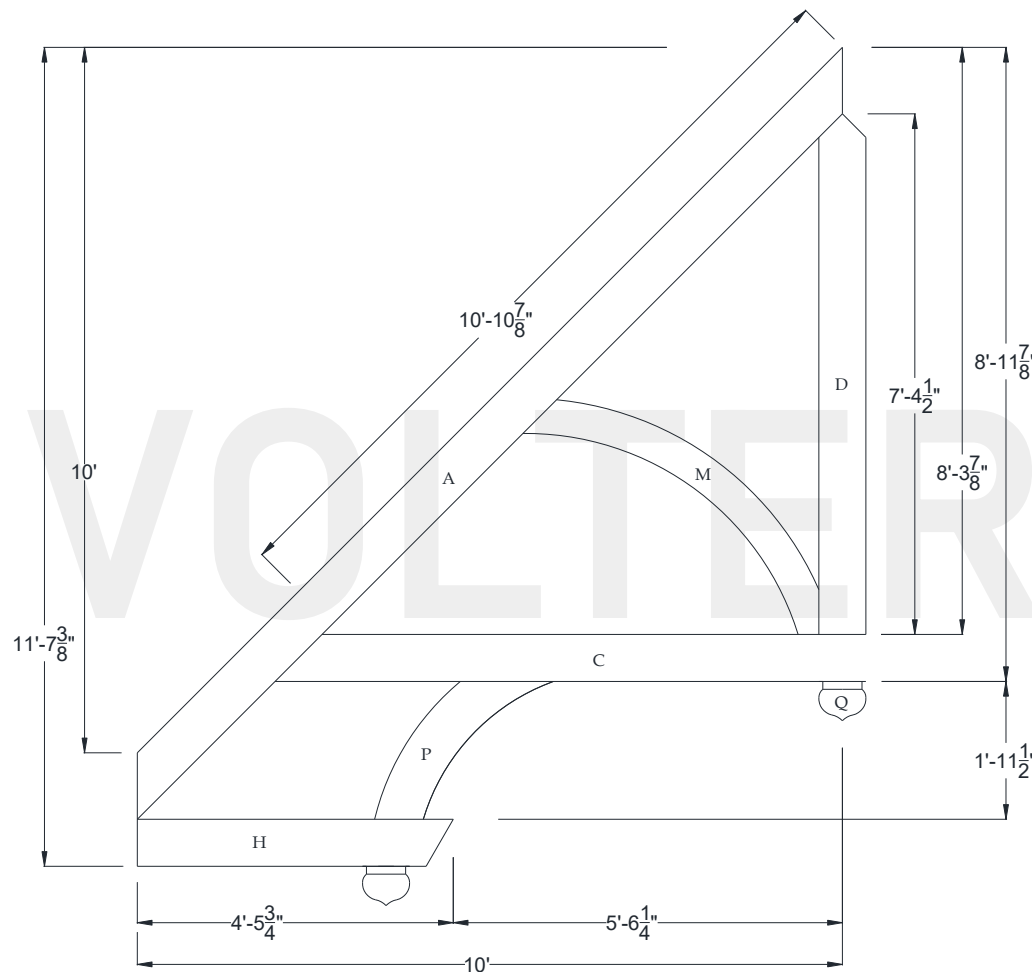

Specifications

Pitch:	12/12
A) Rafter/Top Chord:	8" x 8"
B) Bottom/Tie Chord:	N/A
C) Upper/Tie Chord:	8" x 8"
D) King Post:	8" x 8"
E) Queen Post:	N/A
F) Jack Post:	N/A
G) Hammer Beam Top:	N/A
H) Hammer Beam Btm:	8" x 8"
I) Collar Brace Upper:	N/A
J) Collar Brace Lower:	N/A
K) Hammer Brace:	N/A
L) Wall Post:	N/A
M) Web 1:	6" x 6"
N) Web 2:	N/A
O) Web 3:	N/A
P) Flying Buttress:	8" x 8"
Q) Newel End:	AC



Aspen Truss Recommended Installation Procedures

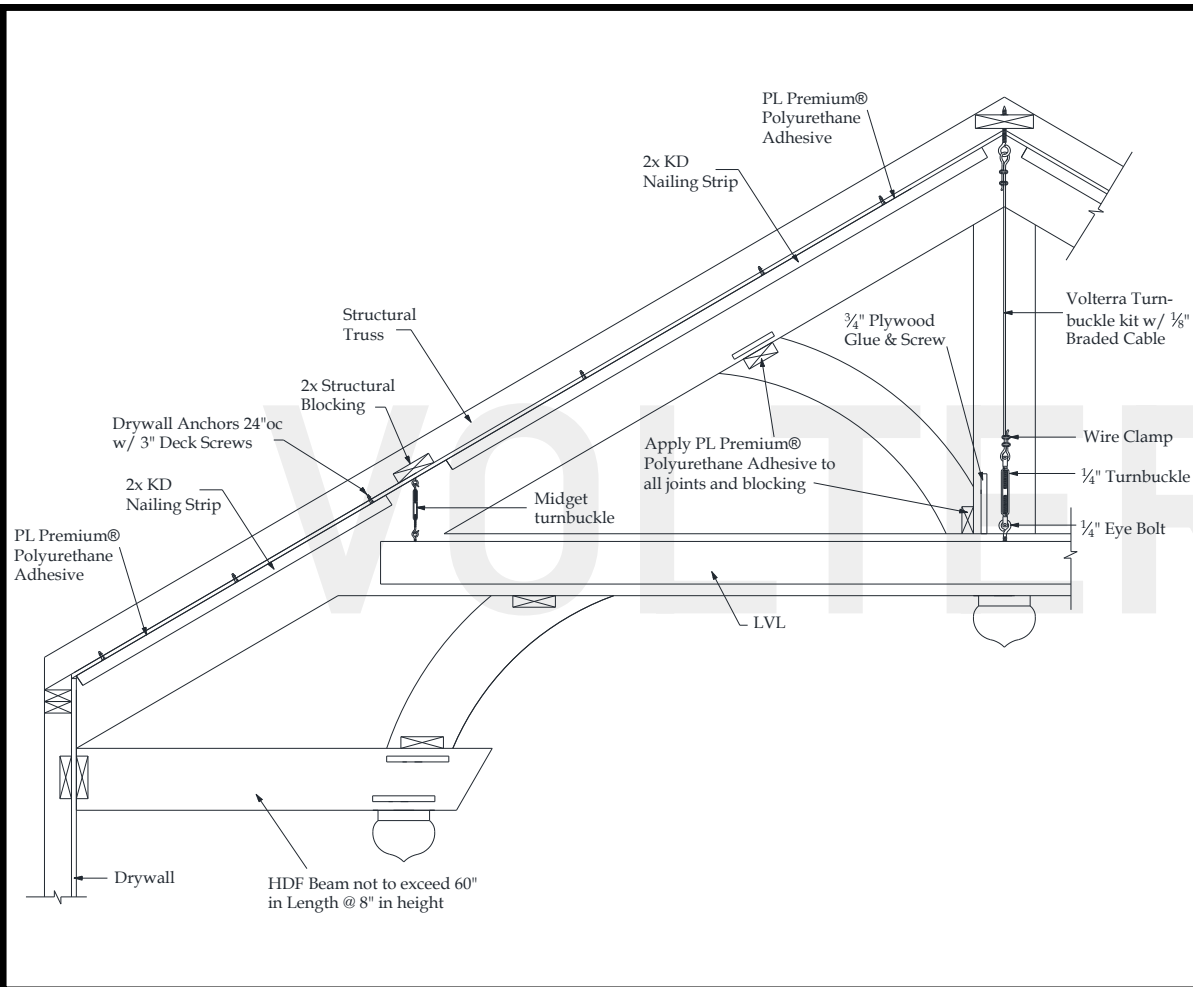

- A:** Layout beams and chalk lines to the inside of rafter beam.
- B:** Screw in threaded eye bolts into structural blocking at ridge and upper tie chord.
- C:** Place KD nailing strip on chalk line and pre-drill $\frac{1}{8}$ " holes 24" on center through strip and into drywall. Install drywall anchors into predrilled holes. Apply $\frac{1}{4}$ " bead of PL adhesive to top of nailing strip and install using deck screws or equal.
- D:** Measure, cut and dry fit rafter beam then pull beam down. Apply PL adhesive to sides of nailing strips. Install rafter beam and use finish screws to secure 24" on center. Install plywood for webbing attachment.
- E:** Cut round hole in bottom of rafter beams for king post turnbuckle. Cut beam pocket for tie chord LVL.
- F:** Install LVL and then measure correct length and cut braided cable and attach eyebolt to center and ends of tie chord.
- G:** Add 2X blocking every 24"OC to LVL so tie chord beam is a tight fit. Install tie chord and its 4th side.
- G:** Glue and screw off plywood plate to inside of king post for connection of web beams. Stain raw foam at ends of king post/ web beams and loose side. Install king post/web beams and their 4th side.
- G:** Install 2x blocking to wall, bottom of tie chord and top of Hammer beam as shown. Install plywood to interior of Hammer beam and glue and screw using PL adhesive and trim screws.
- H:** Patch holes and touch up HDF if necessary.

Volterra Architectural Products LLC – 1902 North 22nd Avenue – Phoenix , AZ 85009 – 602.258.7373

www.volterraproducts.com