

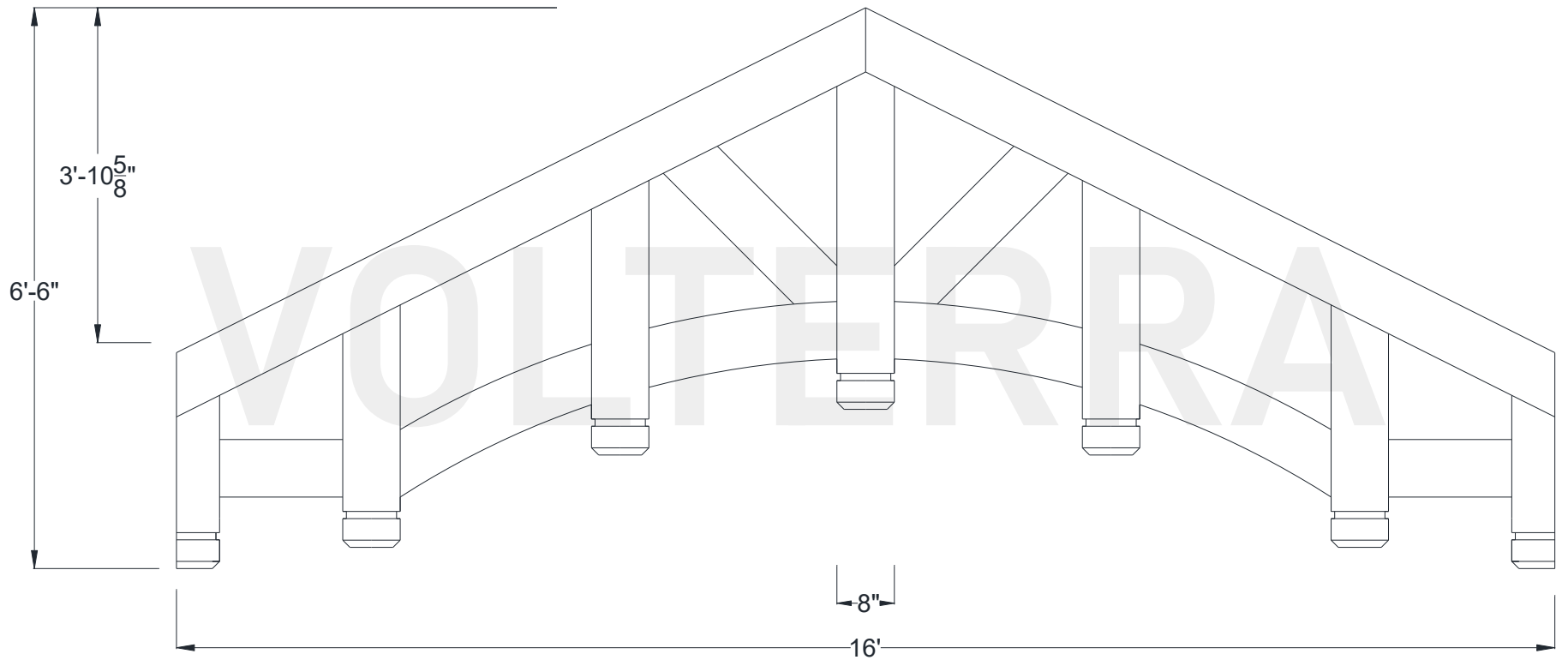

Hawkeye Hammered Truss

192" Width

Shown: 6/12 Pitch



Volterra Architectural Products LLC — 1902 North 22nd Avenue — Phoenix, AZ 85009 — 602.258.7373

www.volterraproducts.com

Hawkeye Hammered Truss

192" Width

Dimension Sheet

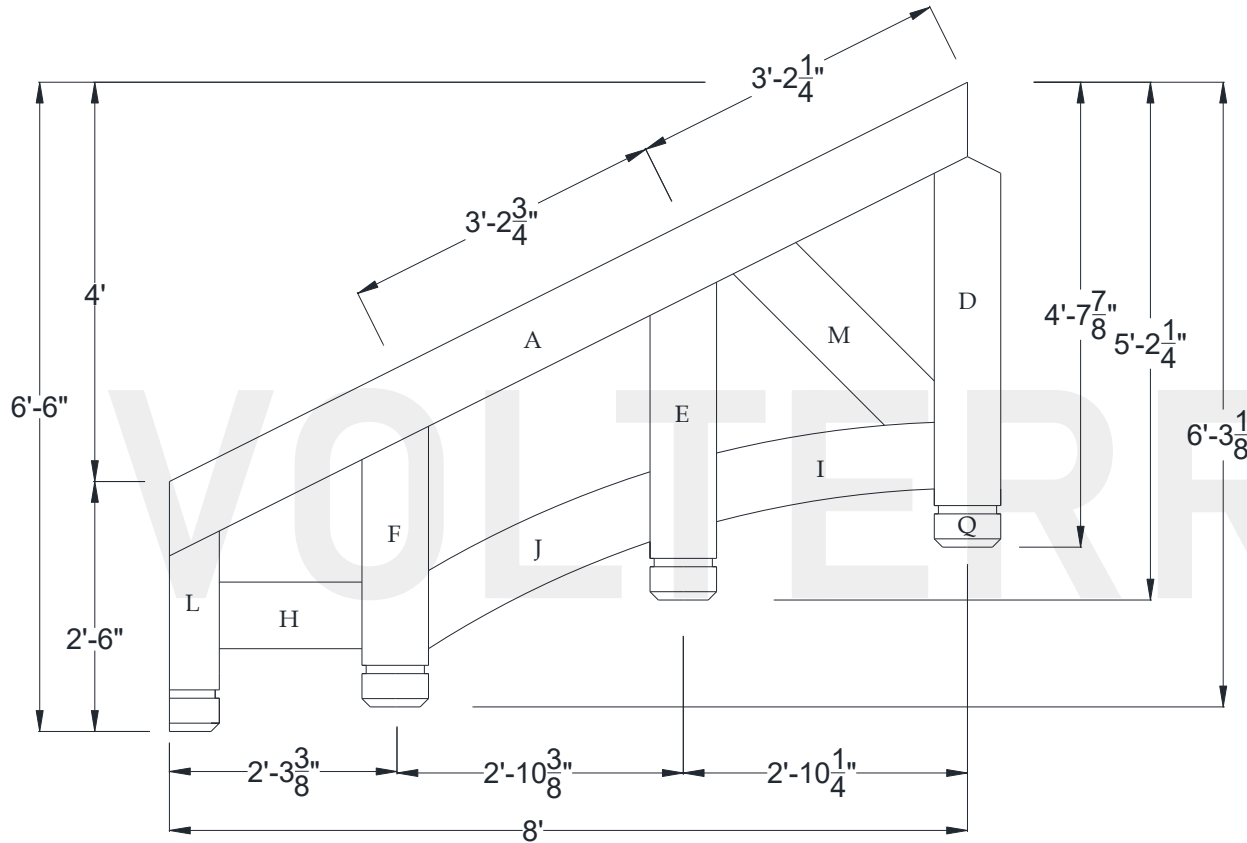

Specifications

Pitch:	6/12
A) Rafter/Top Chord:	8" x 8"
B) Bottom/Tie Chord:	N/A
C) Upper/Tie Chord:	N/A
D) King Post:	8" x 8"
E) Queen Post:	8" x 8"
F) Jack Post:	8" x 8"
G) Hammer Beam Top:	N/A
H) Hammer Beam Btm:	8" x 8"
I) Collar Brace Upper:	8" x 8"
J) Collar Brace Lower:	8" x 8"
K) Hammer Brace:	N/A
L) Wall Post:	8" x 7"
M) Web 1:	8" x 8"
N) Web 2:	N/A
O) Web 3:	N/A
P) Flying Buttress:	N/A
Q) Newel End:	XC



Hawkeye Truss

Recommended Interior Installation Procedures

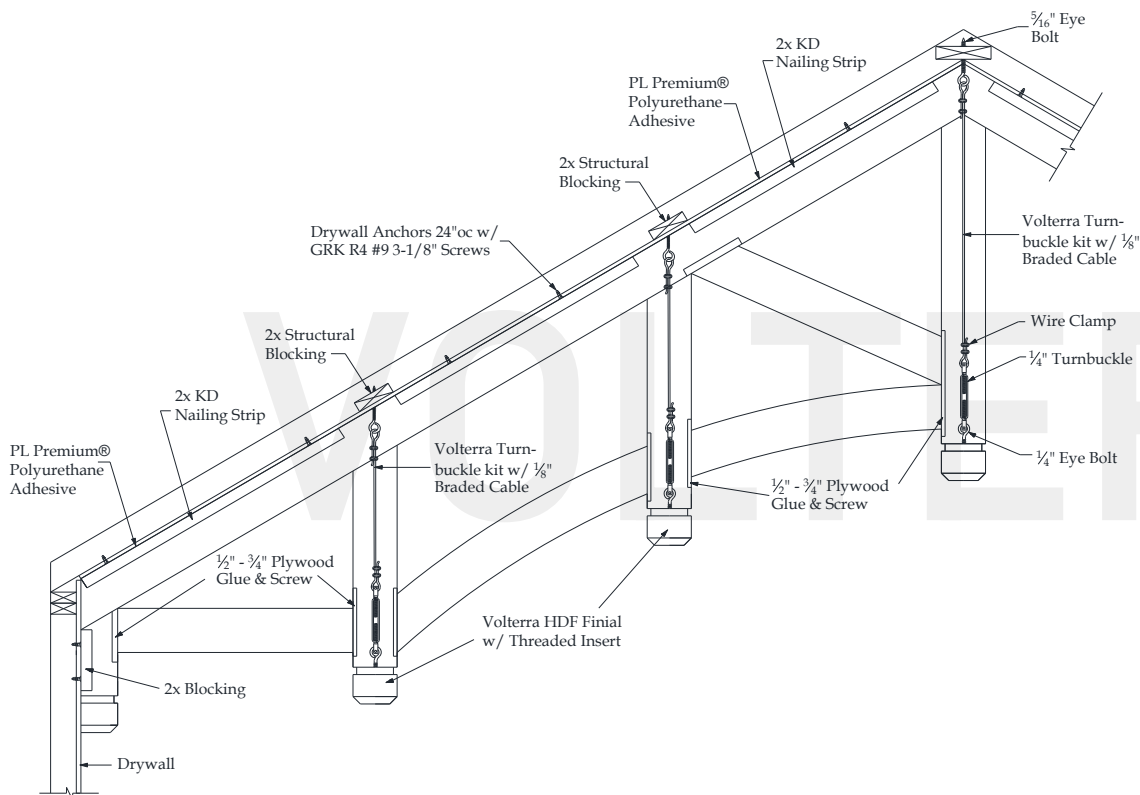

A: Layout beams and chalk lines to the inside of rafter beam.

B: Measure down ridge and screw in threaded eye bolts into structural blocking at all points.

C: Place KD nailing strip on chalk line and pre-drill $\frac{1}{8}$ " holes 24" on center through strip and into drywall. Install drywall anchors into predrilled holes. Apply $\frac{1}{4}$ " bead of PL adhesive to top of nailing strip and install using deck screws.

E: Glue and screw $\frac{1}{2}$ "- $\frac{3}{4}$ " plywood nailing plate to inside of rafter beam for web install.

D: Measure, cut and dry fit rafter beam then pull beam down. Apply PL adhesive to sides of nailing strips. Install rafter beam and use finish screws to secure 24" on center.

E: Cut 3"-4" diameter round hole for king, queen & jack post turnbuckle.

F: Measure correct length and cut braided cable and install turnbuckle kit. Glue and screw off $\frac{1}{2}$ "- $\frac{3}{4}$ " screw plate to inside of king, queen & jack posts for connection of hammer and collar braces. Stain raw foam on king/queen post and loose side. Install king, queen & jack posts and their 4th side.

G: Glue and screw 2x blocks and $\frac{1}{2}$ "- $\frac{3}{4}$ " plywood nailing plate for both wall posts. Measure and cut both posts. Dry fit first. Apply PL adhesive to contact areas. Install using finish screws.

H: Measure, cut and dry fit web and hammer beam. Glue and toe screw in place. Patch holes and touch up HDF if necessary.

Volterra Architectural Products LLC—1902 North 22nd Avenue -Phoenix, AZ 85009 - 1.602.258.7373

www.volterraproducts.com