

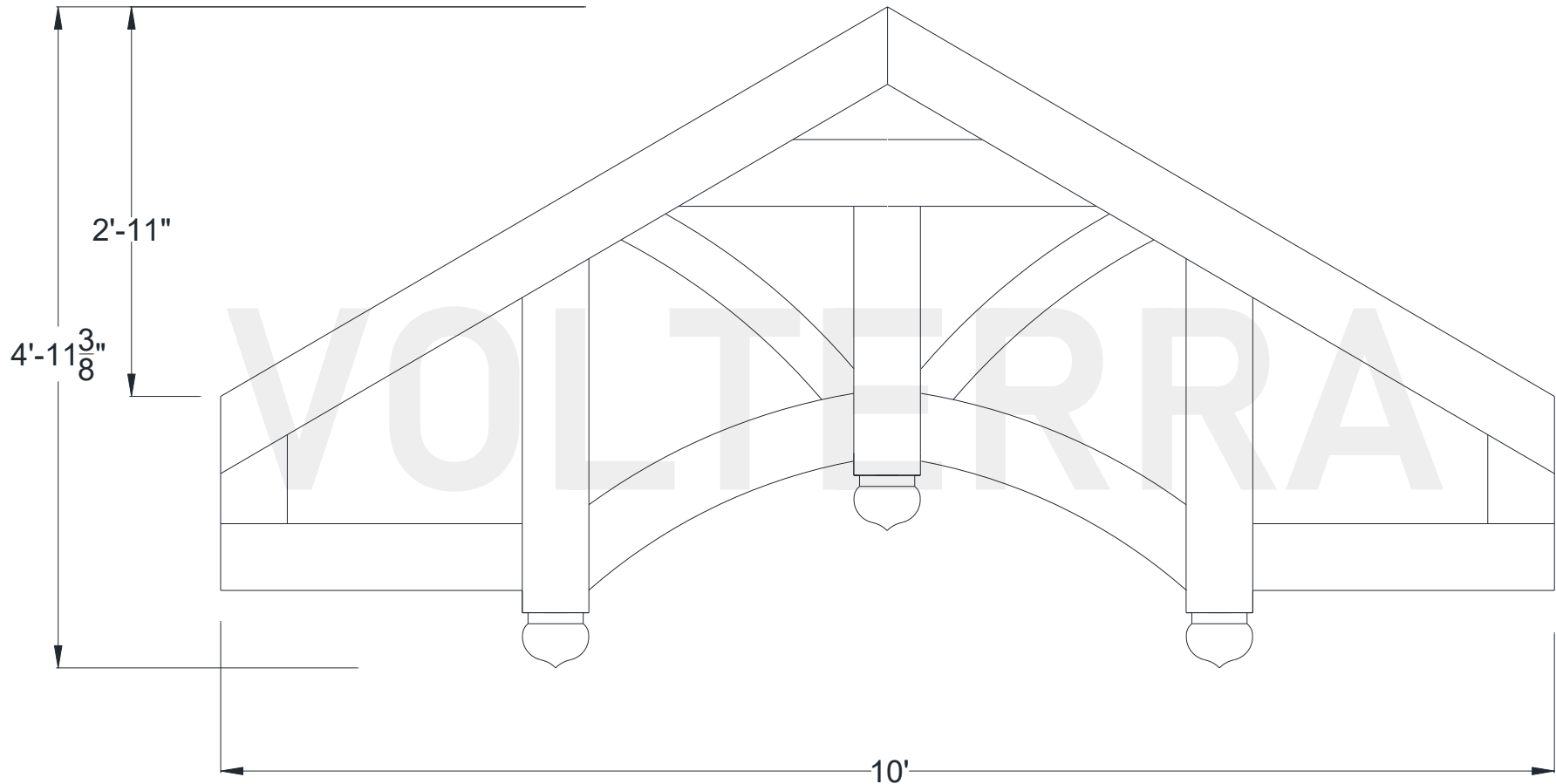

# Wasatch Hammered Truss

120" Width

Shown: 7/12 Pitch



Volterra Architectural Products LLC – 1902 North 22nd Avenue – Phoenix, AZ 85009 – 602.258.7373

[www.volterraproducts.com](http://www.volterraproducts.com)

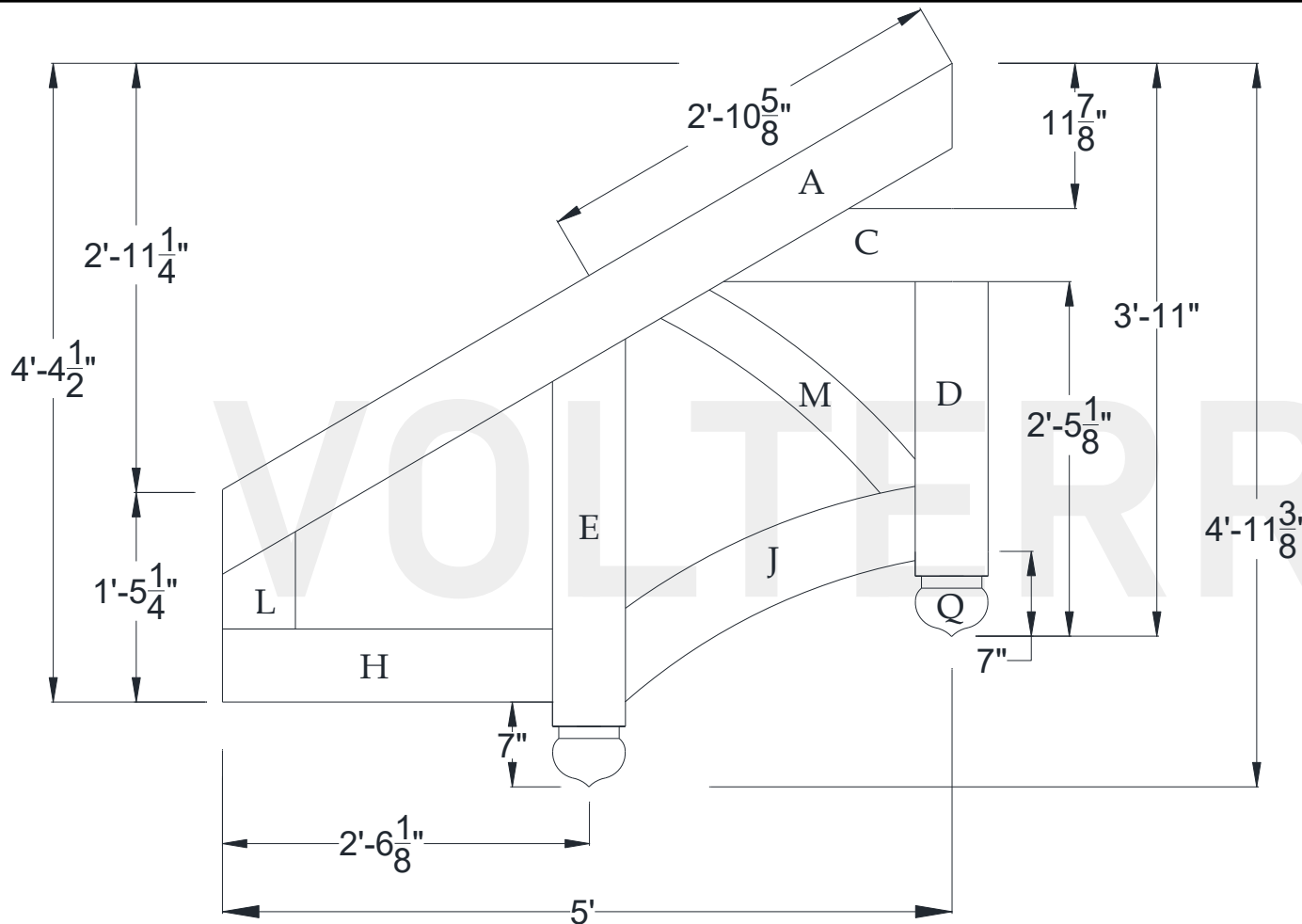

#### Specifications

Pitch:	7/12
A) Rafter/Top Chord:	6"x 6"
B) Bottom/Tie Chord:	N/A
C) Upper/Tie Chord:	6"x 6"
D) King Post:	6"x 6"
E) Queen Post:	6"x 6"
F) Jack Post:	N/A
G) Hammer Beam Top:	N/A
H) Hammer Beam Btm:	6"x 6"
I) Collar Brace Upper:	N/A
J) Collar Brace Lower:	6"x 6"
K) Hammer Brace:	N/A
L) Wall Post:	N/A
M) Web 1:	3"x 3"
N) Web 2:	N/A
O) Web 3:	N/A
P) Flying Buttress:	N/A
Q) Newel End:	AC



## Wasatch Truss Recommended Interior Installation Procedures

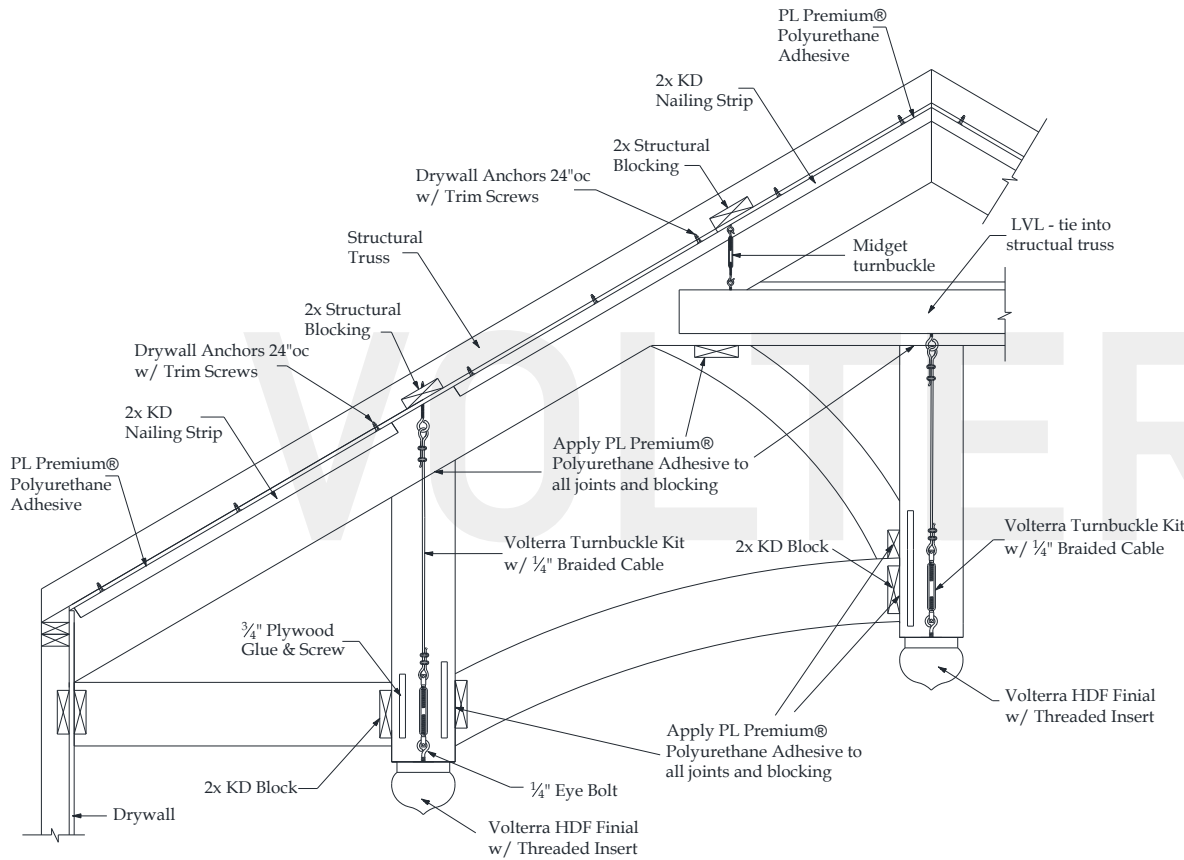

**A:** Layout beams and chalk lines to the inside of rafter beam.

**B:** Measure down ridge and screw in threaded eye bolts into structural blocking at all points.

**C:** Place KD nailing strip on chalk line and pre-drill 1/8" holes 24" on center through strip and into drywall. Install drywall anchors into predrilled holes. Apply 1/4" bead of PI adhesive to top of nailing strip and install using deck screws.

**D:** Measure, cut and dry fit rafter beam then pull beam down. Apply PL adhesive to sides of nailing strips. Install rafter beam and use trim screws to secure 24" on center.

**E:** Cut 3"-6" diameter round hole for queen post turnbuckle. Using a level mark and cut 6" tall x 4"-6" wide square hole for LVL - bottom side of rafter beam.

**F:** Install LVL (screw eyelets in prior to installation) and then upper tie chord. 2x blocking (furring) should be used inside top chord for a tight fit. Cut 3"-4" round hole for turnbuckle on the bottom side of top chord for King Post installation.

**F:** Measure correct length and cut braided cable and install turnbuckle kit. Glue and screw off 3/4" screw plate to inside of king and queen post for connection of hammer and collar brace. Stain raw foam on king/queen post and loose side. Install king/queen posts and their 4th side.

**G:** Glue and screw 2x blocks for both braces. Measure and cut both braces. Dry fit first. Apply PL adhesive to contact areas. Install using trim screws.

**H:** Measure, cut and dry fit web beam. Glue and toe screw in place. Patch holes and touch up HDF if necessary.

Volterra Architectural Products LLC – 1902 North 22nd Avenue – Phoenix , AZ 85009 – 602.258.7373

[www.volterraproducts.com](http://www.volterraproducts.com)