

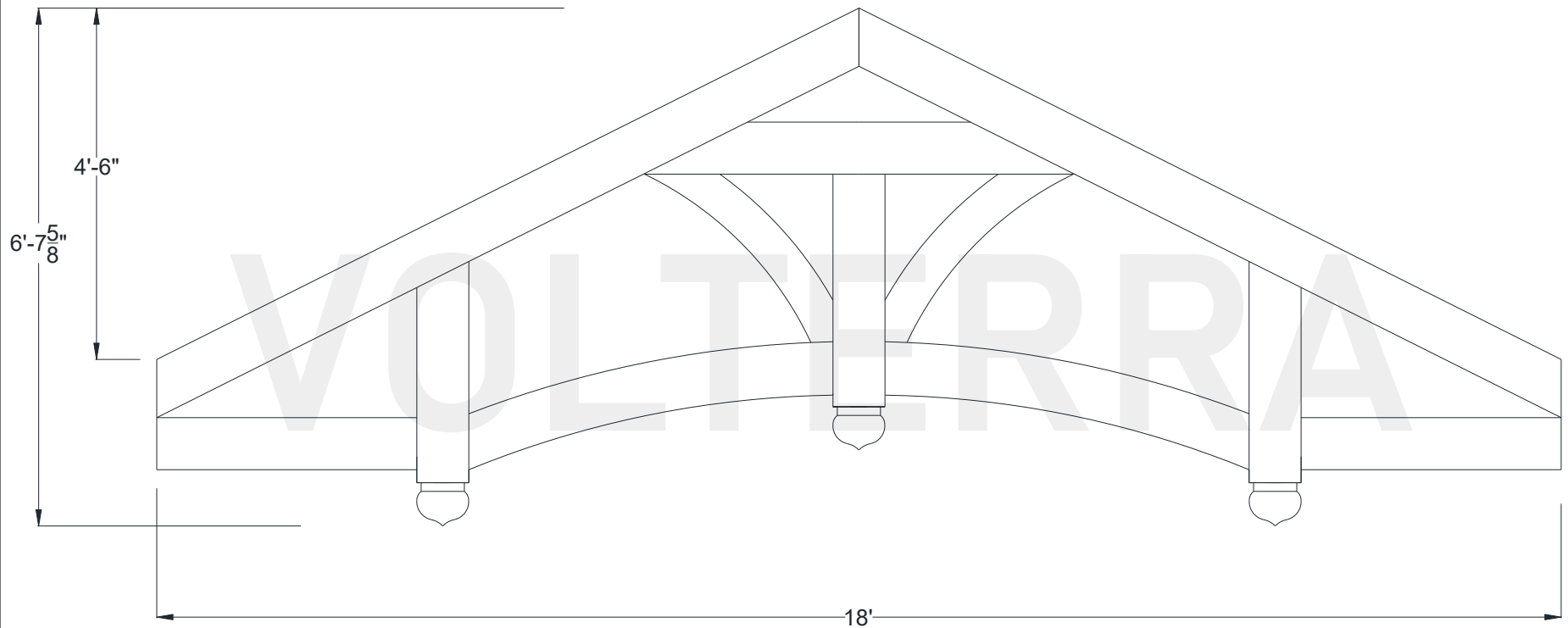

Wasatch Hammered Truss

216" Width

Shown: 6/12 Pitch



Volterra Architectural Products LLC – 1902 North 22nd Avenue – Phoenix, AZ 85009 – 602.258.7373

www.volterraproducts.com

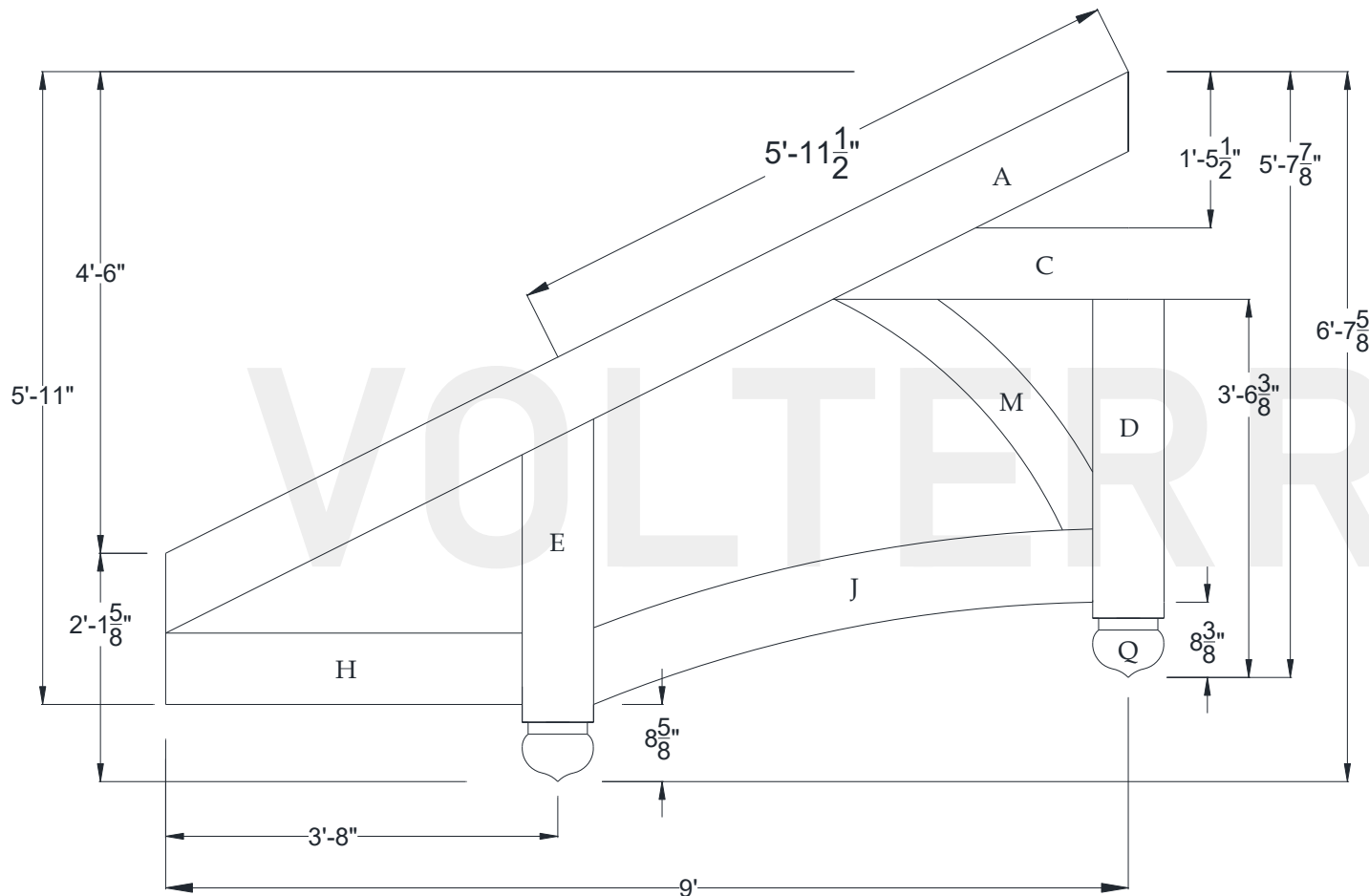

Specifications

| | |
|------------------------|---------|
| Pitch: | 6/12 |
| A) Rafter/Top Chord: | 8" x 8" |
| B) Bottom/Tie Chord: | N/A |
| C) Upper/Tie Chord: | 8" x 8" |
| D) King Post: | 8" x 8" |
| E) Queen Post: | 8" x 8" |
| F) Jack Post: | N/A |
| G) Hammer Beam Top: | N/A |
| H) Hammer Beam Btm: | 8" x 8" |
| I) Collar Brace Upper: | N/A |
| J) Collar Brace Lower: | 8" x 8" |
| K) Hammer Brace: | N/A |
| L) Wall Post: | N/A |
| M) Web 1: | 4" x 4" |
| N) Web 2: | N/A |
| O) Web 3: | N/A |
| P) Flying Buttress: | N/A |
| Q) Newel End: | AC |



Wasatch Truss Recommended Interior Installation Procedures

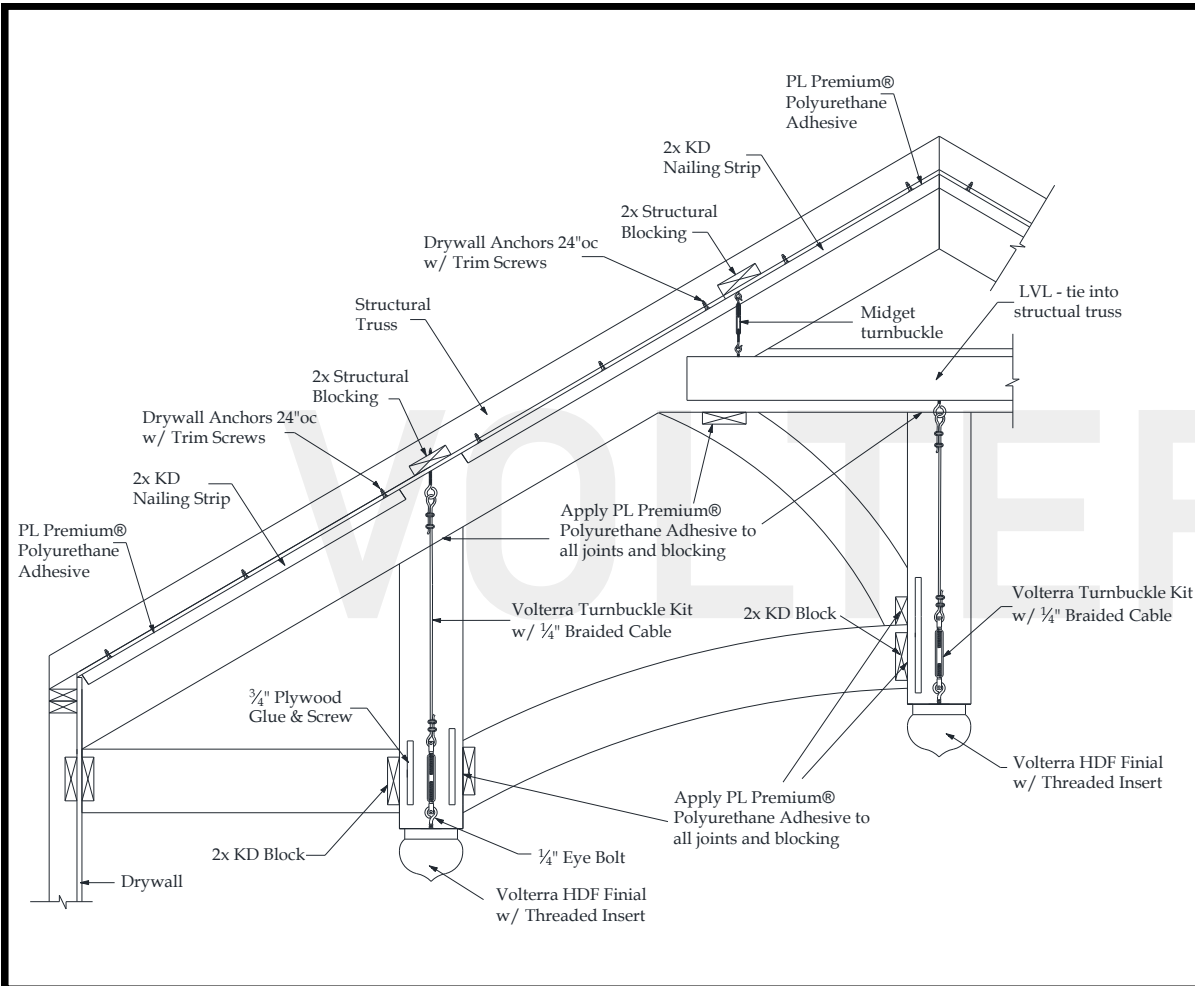

A: Layout beams and chalk lines to the inside of rafter beam.

B: Measure down ridge and screw in threaded eye bolts into structural blocking at all points.

C: Place KD nailing strip on chalk line and pre-drill 1/8" holes 24" on center through strip and into drywall. Install drywall anchors into predrilled holes. Apply 1/4" bead of PI adhesive to top of nailing strip and install using deck screws.

D: Measure, cut and dry fit rafter beam then pull beam down. Apply PL adhesive to sides of nailing strips. Install rafter beam and use trim screws to secure 24" on center.

E: Cut 3"-6" diameter round hole for queen post turnbuckle. Using a level mark and cut 6" tall x 4"-6" wide square hole for LVL - bottom side of rafter beam.

F: Install LVL (screw eyelets in prior to installation) and then upper tie chord. 2x blocking (furring) should be used inside top chord for a tight fit. Cut 3"-4" round hole for turnbuckle on the bottom side of top chord for King Post installation.

F: Measure correct length and cut braided cable and install turnbuckle kit. Glue and screw off 3/4" screw plate to inside of king and queen post for connection of hammer and collar brace. Stain raw foam on king/queen post and loose side. Install king/queen posts and their 4th side.

G: Glue and screw 2x blocks for both braces. Measure and cut both braces. Dry fit first. Apply PL adhesive to contact areas. Install using trim screws.

H: Measure, cut and dry fit web beam. Glue and toe screw in place. Patch holes and touch up HDF if necessary.

Volterra Architectural Products LLC – 1902 North 22nd Avenue – Phoenix , AZ 85009 – 602.258.7373

www.volterraproducts.com