

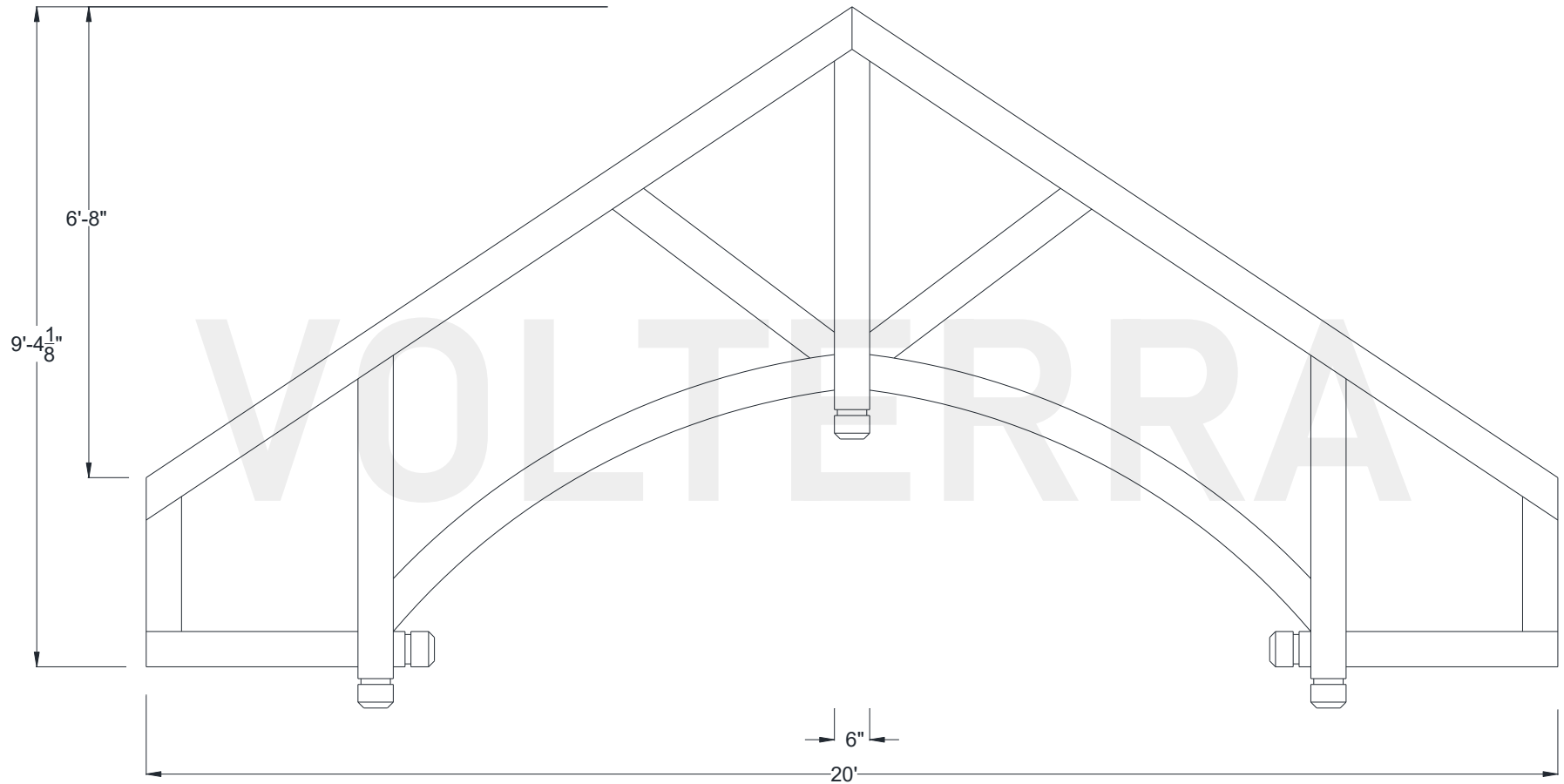

Braddock Hammered Truss

240" Width

Shown: 8/12 Pitch



Volterra Architectural Products LLC — 1902 North 22nd Avenue — Phoenix, AZ 85009 — 602.258.7373

www.volterraproducts.com

Braddock Hammered Truss

240" Width

Dimension Sheet

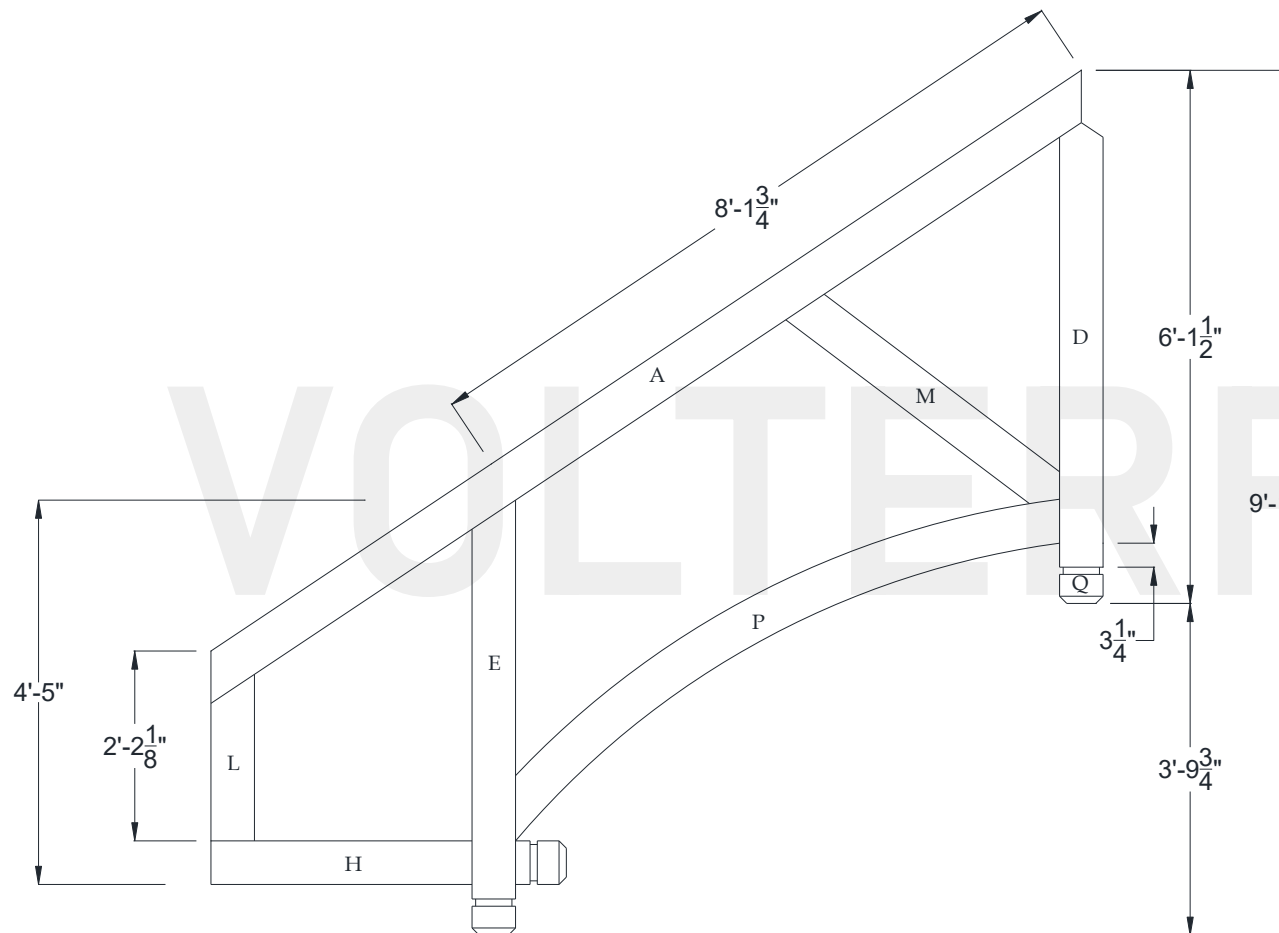

Specifications

Pitch:	8/12
A) Rafter/Top Cord:	6" x 6"
B) Bottom/Tie Cord:	N/A
C) Upper/Tie Cord:	N/A
D) King Post:	6" x 6"
E) Queen Post:	6" x 6"
F) Jack Post:	N/A
G) Hammer Beam Top:	N/A
H) Hammer Beam Btm:	6" x 6"
I) Collar Brace Upper:	N/A
J) Collar Brace Lower:	N/A
K) Hammer Brace:	N/A
L) Wall Post:	6" x 6"
M) Web 1:	6" x 6"
N) Web 2:	N/A
O) Web 3:	N/A
P) Flying Buttress:	6" x 6"
Q) Newel End:	XC



Braddock Truss Recommended Interior Installation Procedures

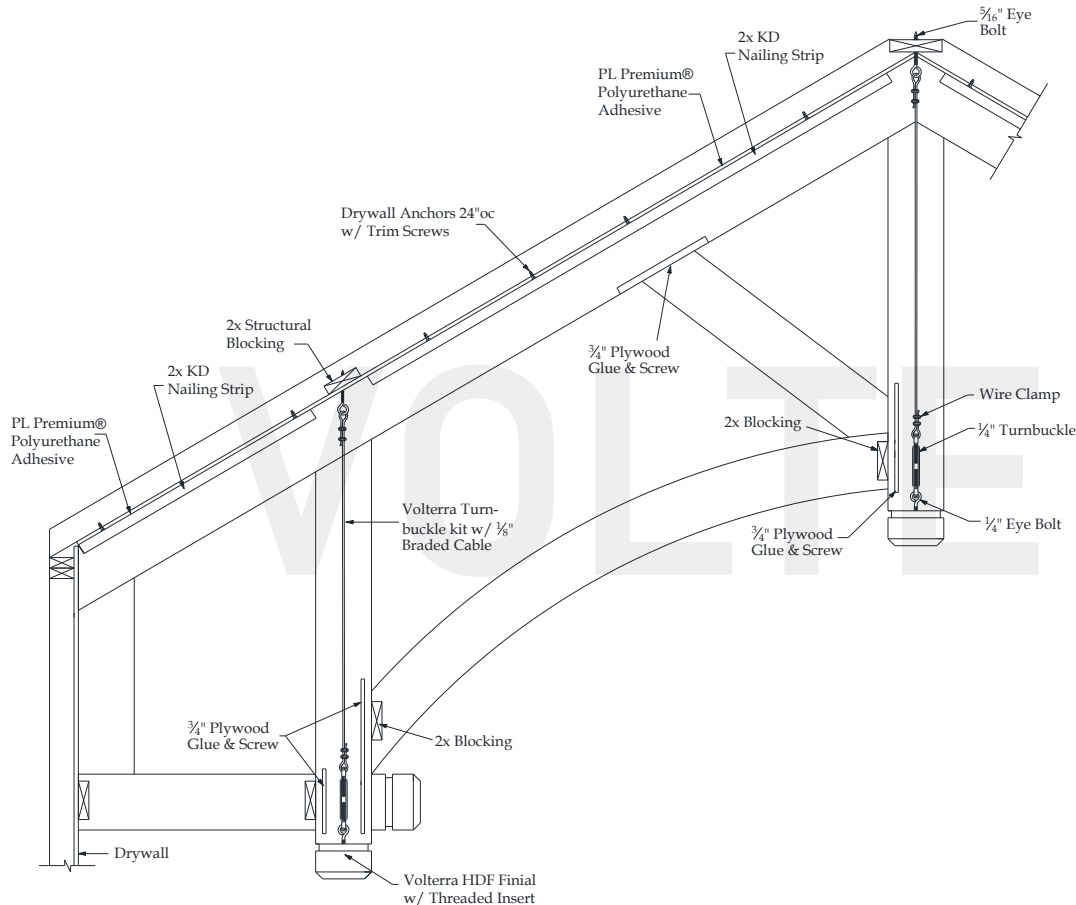

A: Layout beams on ceiling and chalk lines to the inside of rafter beam.

B: Measure down ridge and screw in threaded eye bolts into structural blocking at all points.

C: Place KD nailing strip on chalk line and pre-drill $\frac{1}{8}$ " holes 24" on center through strip and into drywall. Install drywall anchors into predrilled holes. Apply $\frac{1}{4}$ " bead of PL adhesive to top of nailing strip and install using deck screws.

D: Measure, cut and dry fit rafter beam then pull beam down. Apply PL adhesive to sides of nailing strips. Install rafter beam and use finish screws to secure 24" on center.

E: Cut 3"-4" diameter round hole for king/queen post turnbuckles.

F: Measure correct length and cut braided cable and install turnbuckle kit. Glue and screw off $\frac{3}{4}$ " screw plate to inside of king and queen post for connection of hammer beam, web and flying buttress. Stain raw foam on king/queen post and loose side. Install king/queen posts and their 4th side.

G: Glue and screw 2x blocks for hammer beam and flying buttress. Measure and cut parts. Dry fit first. Apply PL adhesive to contact areas. Install using trim screws.

H: Measure, cut and dry fit web beam. Glue and toe screw in place. Patch holes and touch up HDF if necessary.

Volterra Architectural Products LLC — 1902 North 22nd Avenue — Phoenix, AZ 85009 — 602.258.7373

www.volterraproducts.com