

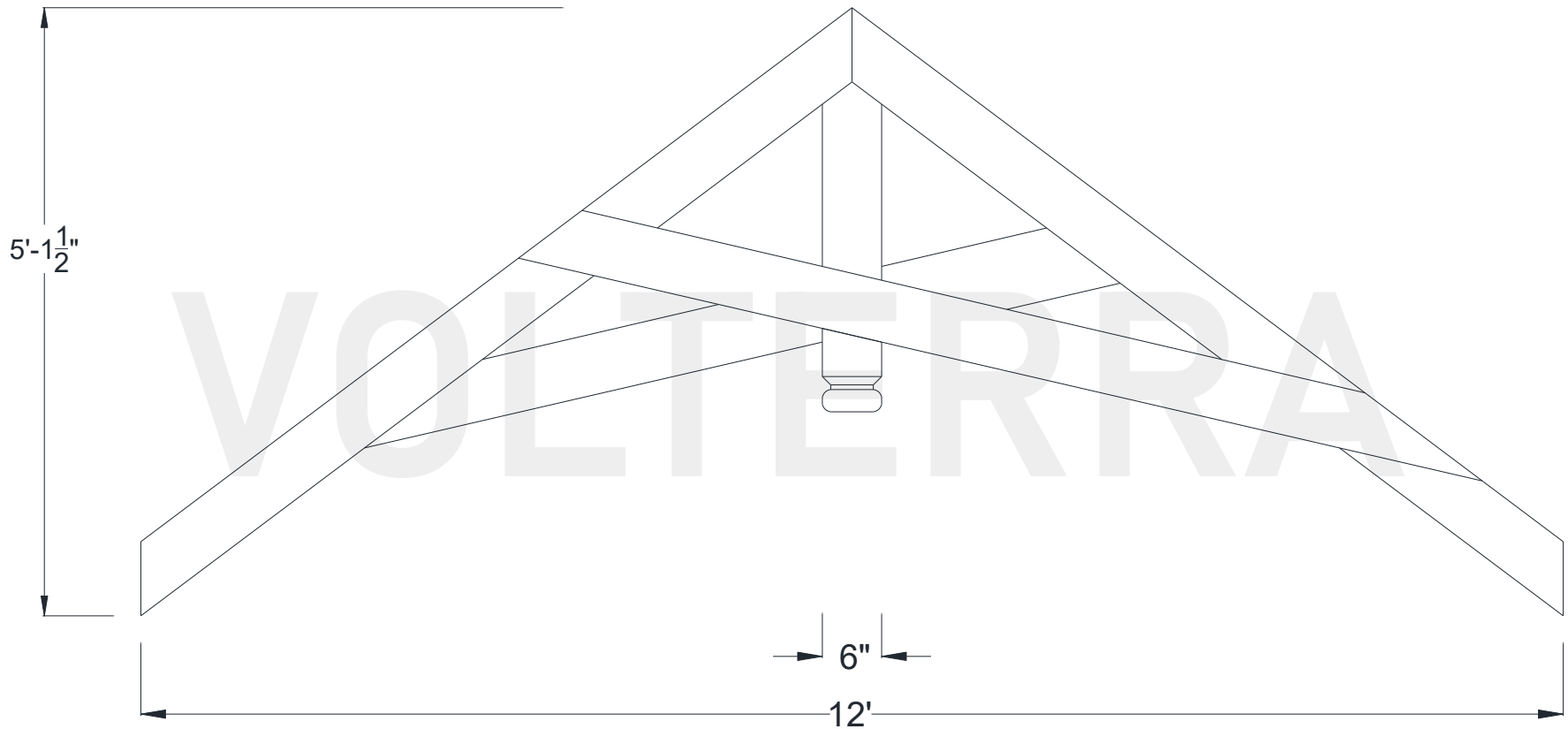

Catskill Truss

144" Width

Shown: 9/12 Pitch



Volterra Architectural Products LLC – 1902 North 22nd Avenue – Phoenix, AZ 85009 – 602.258.7373

www.volterraproducts.com

Catskill Truss

144" Width

Dimension Sheet

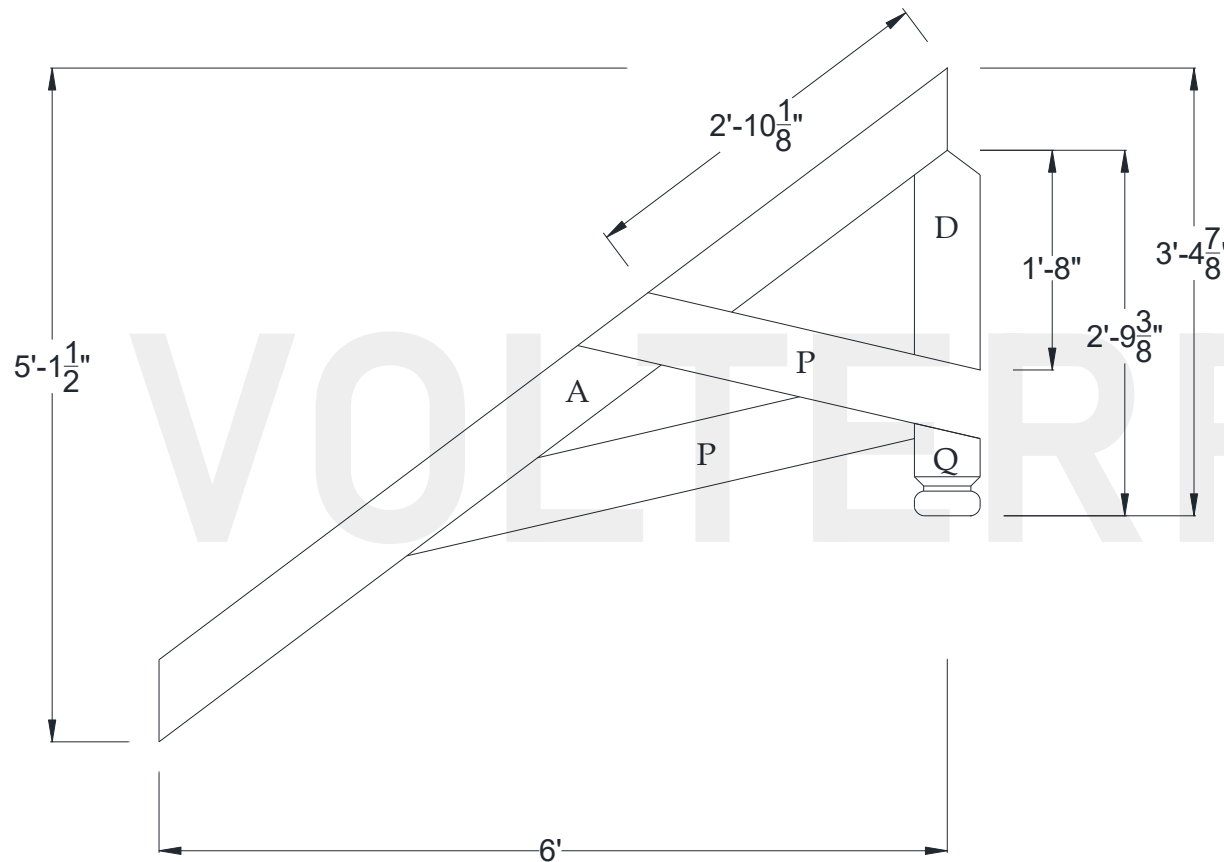

Specifications

Pitch:	9/12
A) Rafter/Top Chord:	6" x 6"
B) Bottom/Tie Chord:	N/A
C) Upper/Tie Chord:	N/A
D) King Post:	6" x 6"
E) Queen Post:	N/A
F) Jack Post:	N/A
G) Hammer Beam Top:	N/A
H) Hammer Beam Btm:	N/A
I) Collar Brace Upper:	N/A
J) Collar Brace Lower:	N/A
K) Hammer Brace:	N/A
L) Wall Post:	N/A
M) Web 1:	N/A
N) Web 2:	N/A
O) Web 3:	N/A
P) Flying Buttress:	2" x 6"
Q) Newel End:	CL



Catskill Truss

Recommended Interior Installation Procedures



A: Layout beams and chalk lines to the inside of rafter beam.

B: Screw in threaded eye bolts into structural blocking at ridge.

C: Place KD nailing strip on chalk line and pre-drill $\frac{1}{8}$ " holes 24" on center through strip and into drywall. Install drywall anchors into predrilled holes. Apply $\frac{1}{4}$ " bead of PL adhesive to top of nailing strip and install using deck screws.

D: Measure, cut and dry fit rafter beam then pull beam down. Apply PL adhesive to sides of nailing strips. Install rafter beam and use trim screws to secure 24" on center.

E: Cut 3"-4" diameter round hole for king post turnbuckle.

F: Measure correct length and cut braided cable and install turnbuckle kit. Stain raw foam on king post and loose side. Install king post and its 4th side.

I: Measure, cut and dry fit flying buttress beams. Lightly mark/pencil line on top and bottom of flying buttress. Apply a minimum of 2-3 @ $\frac{1}{4}$ " beads of PL Premium Adhesive to king post and rafters. Hold flying buttress in place and screw a minimum of 2 trim screws to each connection point. Patch holes and touch up HDF if necessary.

Volterra Architectural Products LLC – 1902 North 22nd Avenue – Phoenix, AZ 85009 – 602.258.7373

www.volterraproducts.com