

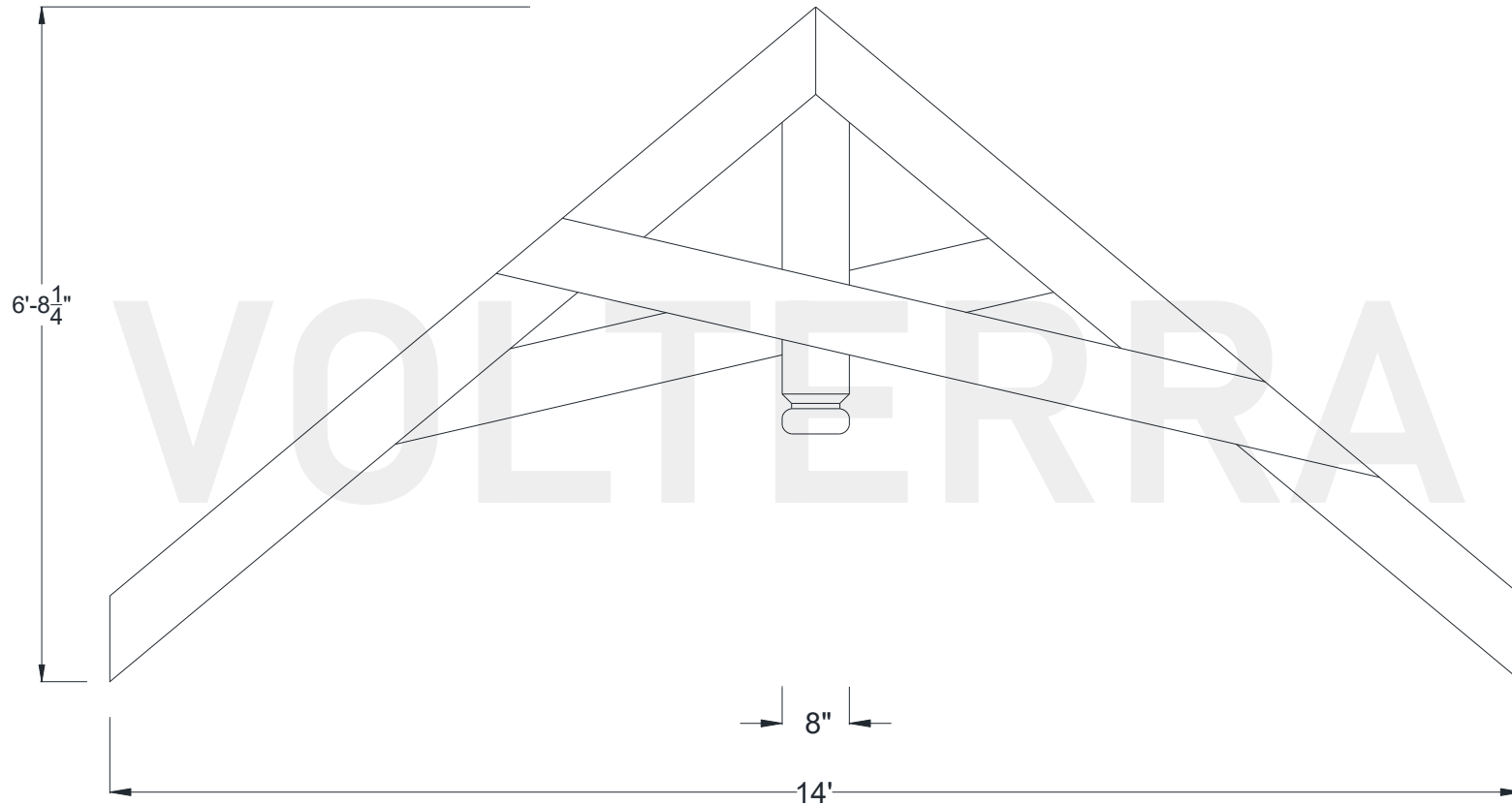

## Catskill Truss

168" Width

Shown: 10/12 Pitch



Volterra Architectural Products LLC – 1902 North 22nd Avenue – Phoenix, AZ 85009 – 602.258.7373

[www.volterraproducts.com](http://www.volterraproducts.com)

**Catskill Truss**  
**168" Width**  
**Dimension Sheet**

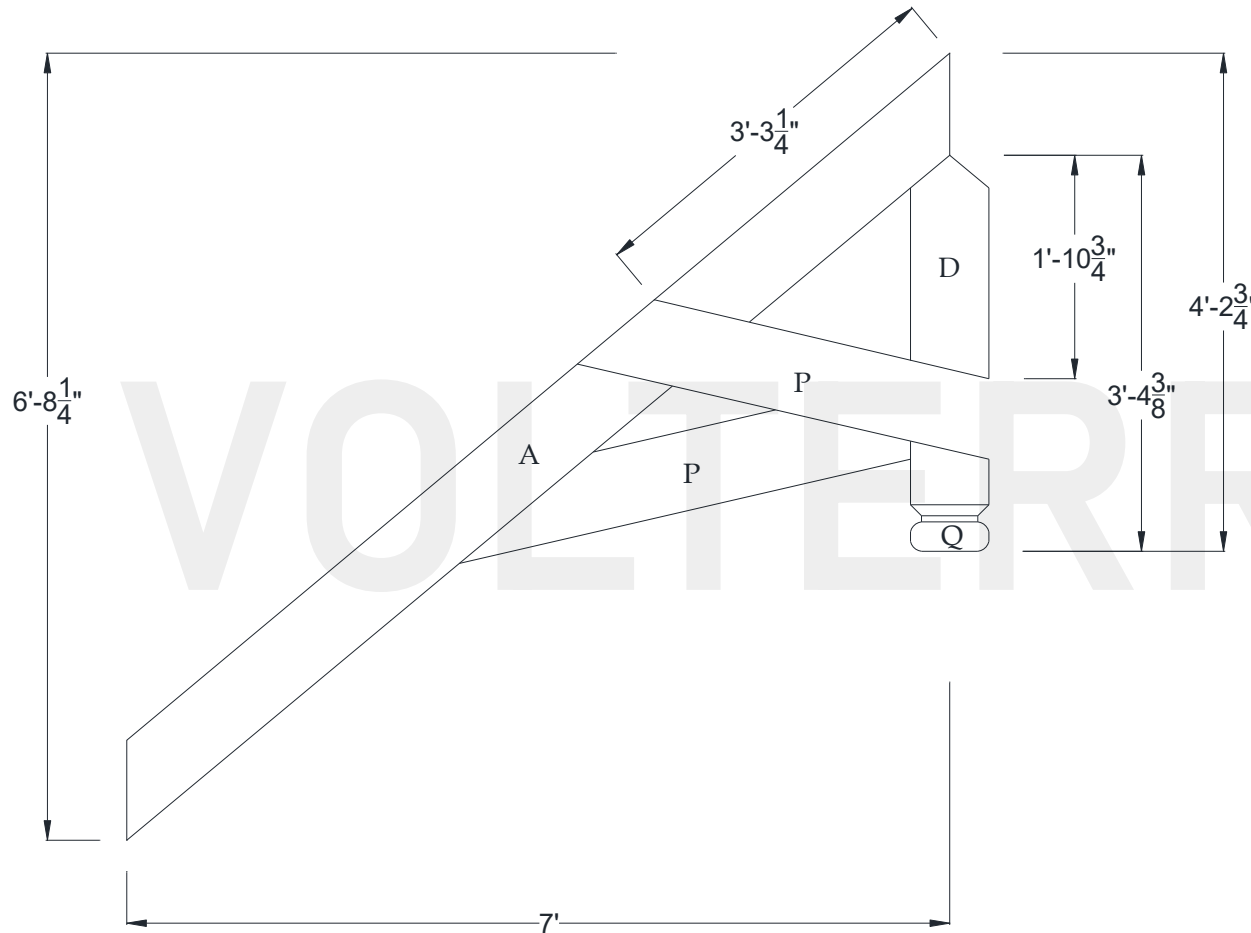

**Specifications**

Pitch:	10/12
A) Rafter/Top Chord:	8" x 8"
B) Bottom/Tie Chord:	N/A
C) Upper/Tie Chord:	N/A
D) King Post:	8" x 8"
E) Queen Post:	N/A
F) Jack Post:	N/A
G) Hammer Beam Top:	N/A
H) Hammer Beam Btm:	N/A
I) Collar Brace Upper:	N/A
J) Collar Brace Lower:	N/A
K) Hammer Brace:	N/A
L) Wall Post:	N/A
M) Web 1:	N/A
N) Web 2:	N/A
O) Web 3:	N/A
P) Flying Buttress:	2" x 8"
Q) Newel End:	CL



## Catskill Truss

### Recommended Interior Installation Procedures



**A:** Layout beams and chalk lines to the inside of rafter beam.

**B:** Screw in threaded eye bolts into structural blocking at ridge.

**C:** Place KD nailing strip on chalk line and pre-drill  $\frac{1}{8}$ " holes 24" on center through strip and into drywall. Install drywall anchors into predrilled holes. Apply  $\frac{1}{4}$ " bead of PL adhesive to top of nailing strip and install using deck screws.

**D:** Measure, cut and dry fit rafter beam then pull beam down. Apply PL adhesive to sides of nailing strips. Install rafter beam and use trim screws to secure 24" on center.

**E:** Cut 3"-4" diameter round hole for king post turnbuckle.

**F:** Measure correct length and cut braided cable and install turnbuckle kit. Stain raw foam on king post and loose side. Install king post and its 4th side.

**I:** Measure, cut and dry fit flying buttress beams. Lightly mark/pencil line on top and bottom of flying buttress. Apply a minimum of 2-3 @  $\frac{1}{4}$ " beads of PL Premium Adhesive to king post and rafters. Hold flying buttress in place and screw a minimum of 2 trim screws to each connection point. Patch holes and touch up HDF if necessary.

Volterra Architectural Products LLC – 1902 North 22nd Avenue – Phoenix, AZ 85009 – 602.258.7373

[www.volterraproducts.com](http://www.volterraproducts.com)