

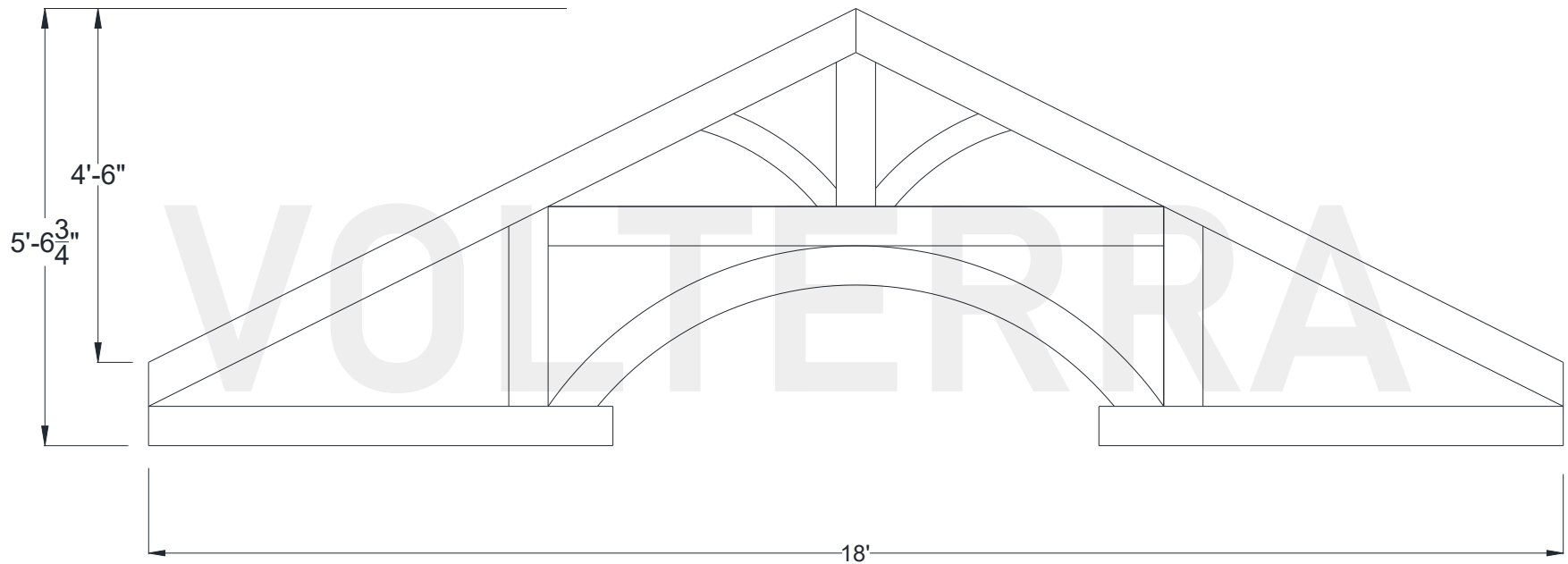

Oxford Hammered Truss

216" Width

Shown: 6/12 Pitch



Volterra Architectural Products LLC – 1902 North 22nd Avenue – Phoenix, AZ 85009 – 602.258.7373

www.volterraproducts.com

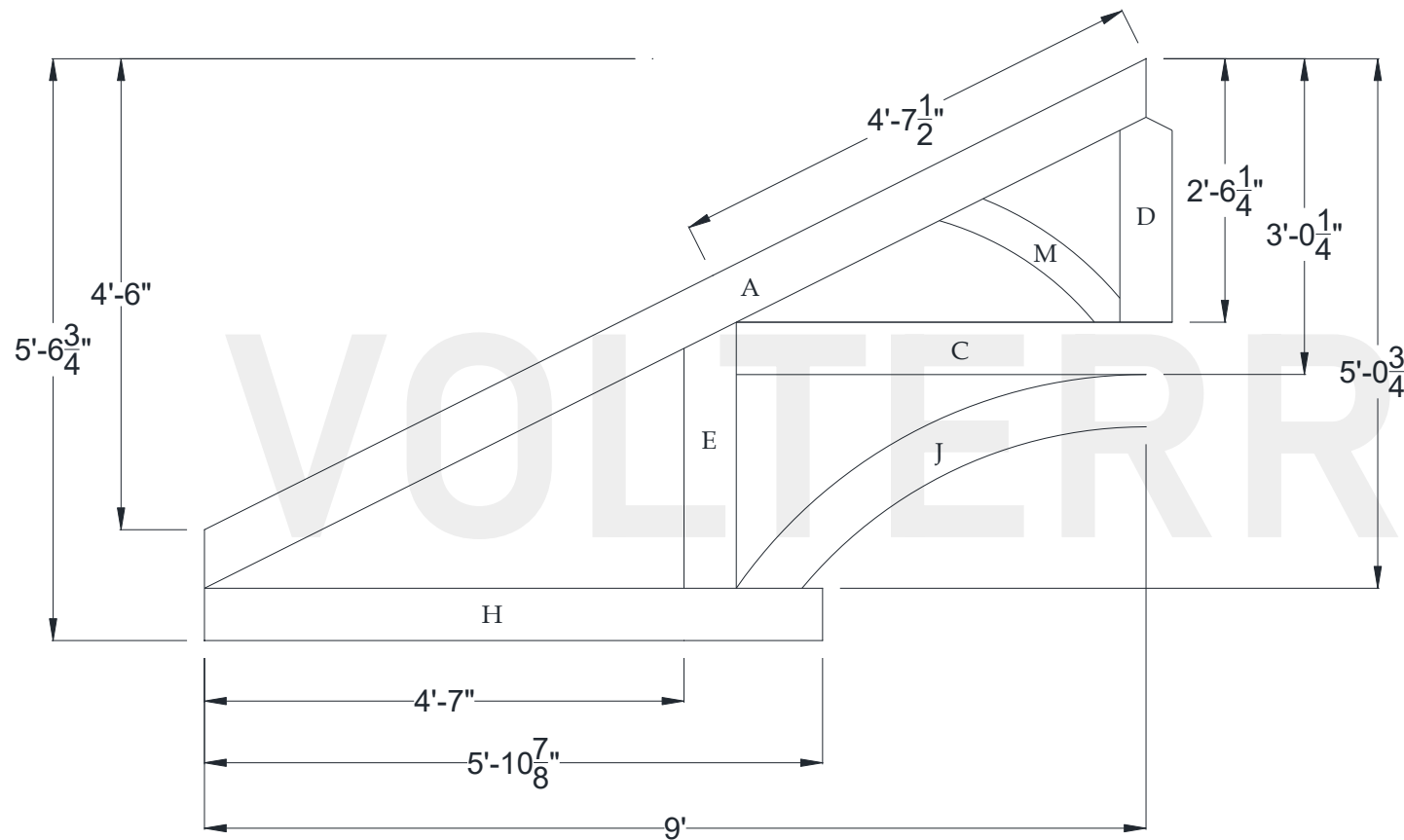

Specifications

Pitch:	6/12
A) Rafter/Top Chord:	6" x 6"
B) Bottom/Tie Chord:	N/A
C) Upper/Tie Chord:	6" x 6"
D) King Post:	6" x 6"
E) Queen Post:	6" x 6"
F) Jack Post:	N/A
G) Hammer Beam Top:	N/A
H) Hammer Beam Btm:	6" x 6"
I) Collar Brace Upper:	N/A
J) Arched Collar Brace:	6" x 6"
K) Hammer Brace:	N/A
L) Wall Post:	N/A
M) Web 1:	4" x 4"
N) Web 2:	N/A
O) Web 3:	N/A
P) Flying Buttress:	N/A
Q) Newel End:	N/A



Oxford Truss Recommended Interior Installation Procedures

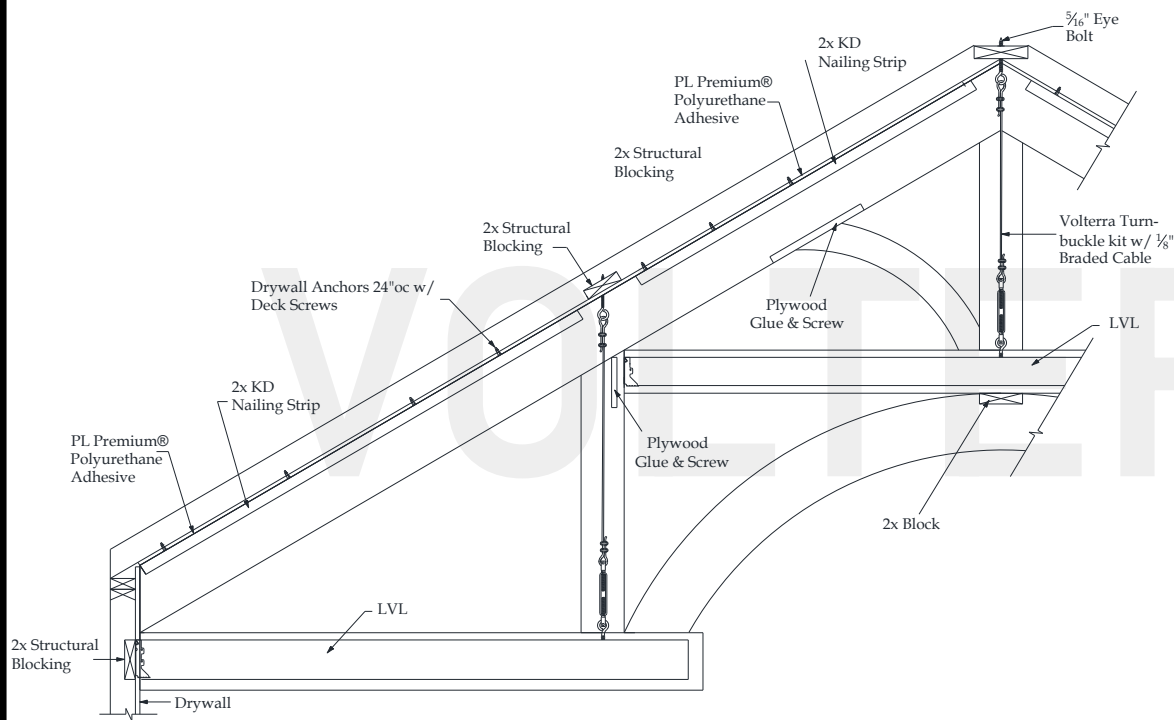

A: Layout beams and chalk lines to the inside of rafter beam.

B: Screw in threaded eye bolts into structural blocking at ridge and queen post.

C: Place KD nailing strip on chalk line and pre-drill $\frac{1}{8}$ " holes 24" on center through strip and into drywall. Install drywall anchors into predrilled holes. Apply $\frac{1}{4}$ " bead of PL adhesive to top of nailing strip and install using deck screws.

D: Measure, cut and dry fit rafter beam then pull beam down. Apply PL adhesive to sides of nailing strips. Install rafter beam and use finish screws to secure 24" on center. Install plywood for webbing attachment.

E: Cut round hole in bottom of rafter beams for king and queen posts turnbuckle.

F: Install LVL hanger on wall and cable down from queen post hole. Install 2x blocking to LVL so hammer beam is a tight fit. Install hammer beam and its 4th side.

G: Install plywood screw plate to inside of queen post. Stain raw foam at ends of queen posts beams and loose side. then install queen post and its 4th side. Install LVL for upper tie chord using same procedures as hammer beam.

G: Install king post and web beams using same procedures as queen posts.

G: Install block to bottom of tie chord. Install arched beam and glue and screw using PL adhesive and trim screws at all connection points.

H: Patch holes and touch up HDF if necessary.

Volterra Architectural Products LLC – 1902 North 22nd Avenue – Phoenix, AZ 85009 – 602.258.7373

www.volterraproducts.com