

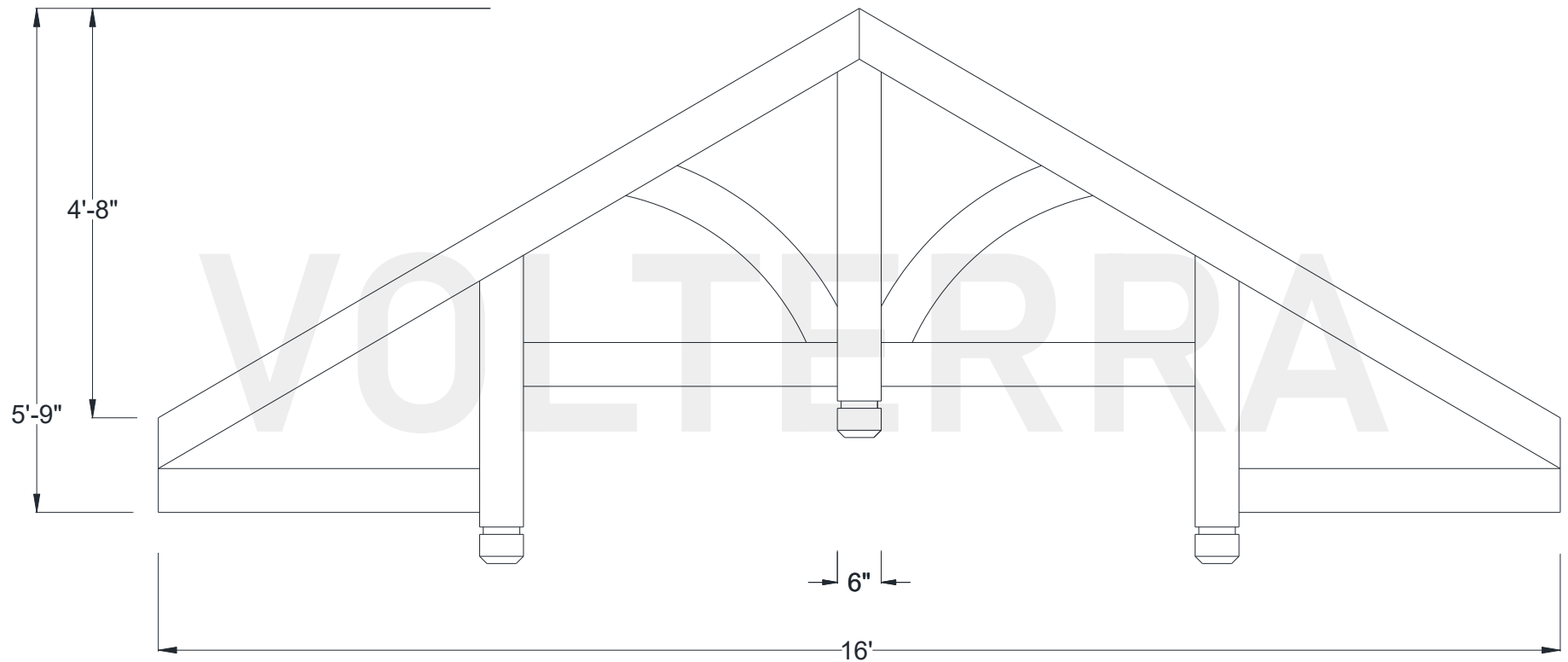

# Cascade Hammered Truss

192" Width

Shown: 7/12 Pitch



Volterra Architectural Products LLC — 1902 North 22nd Avenue — Phoenix, AZ 85009 — 602.258.7373

[www.volterraproducts.com](http://www.volterraproducts.com)

# Cascade Hammered Truss

192" Width

## Dimension Sheet

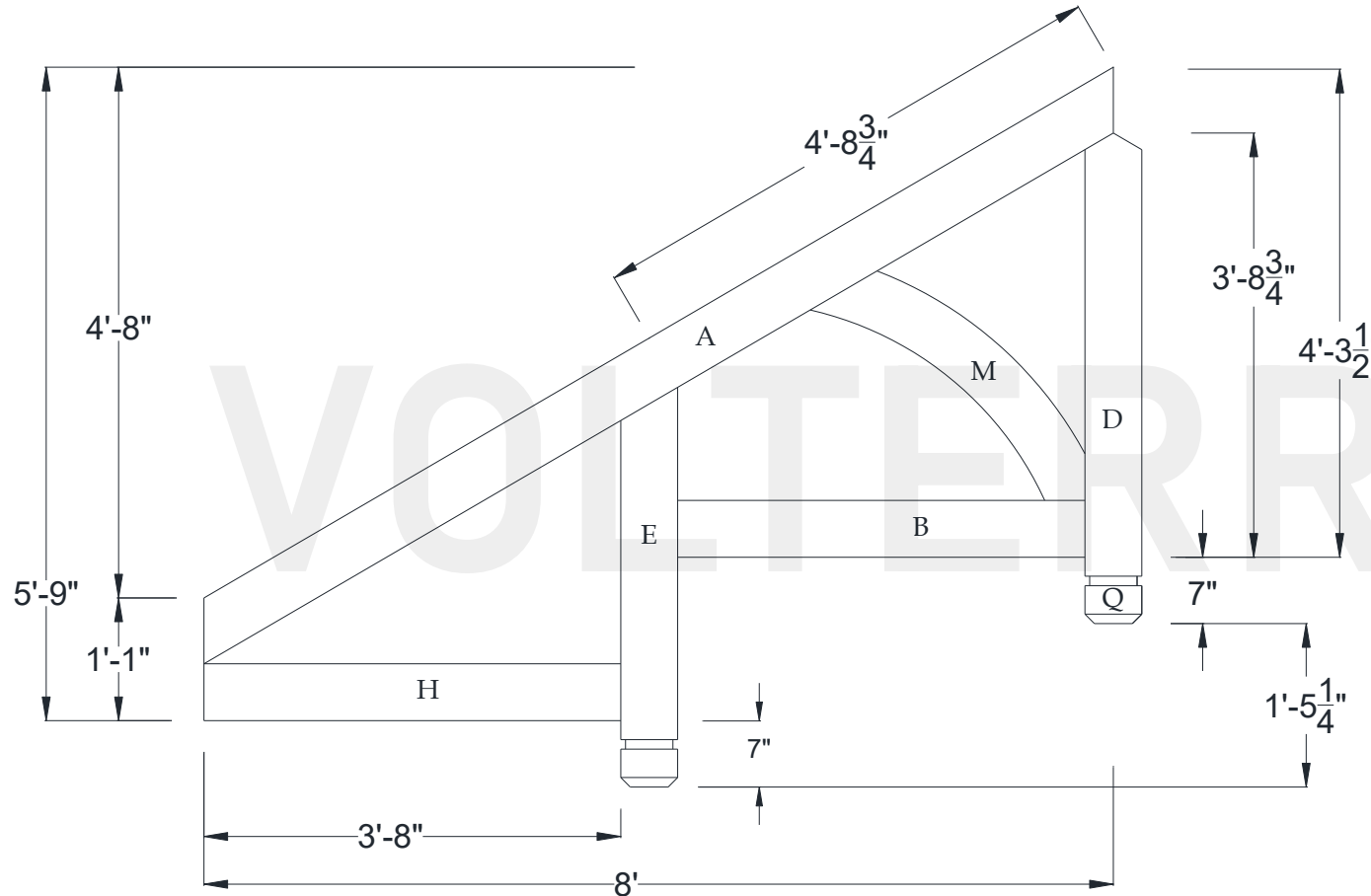

### Specifications

Pitch:	7/12
A) Rafter/Top Chord:	6" x 6"
B) Bottom/Tie Chord:	6" x 6"
C) Upper/Tie Chord:	N/A
D) King Post:	6" x 6"
E) Queen Post:	6" x 6"
F) Jack Post:	N/A
G) Hammer Beam Top:	N/A
H) Hammer Beam Btm:	6" x 6"
I) Collar Brace Upper:	N/A
J) Collar Brace Lower:	N/A
K) Hammer Brace:	N/A
L) Wall Post:	N/A
M) Web 1:	4" x 4"
N) Web 2:	N/A
O) Web 3:	N/A
P) Flying Buttress:	N/A
Q) Newel End:	XC



## Cascade Truss

### Recommended Interior Installation Procedures

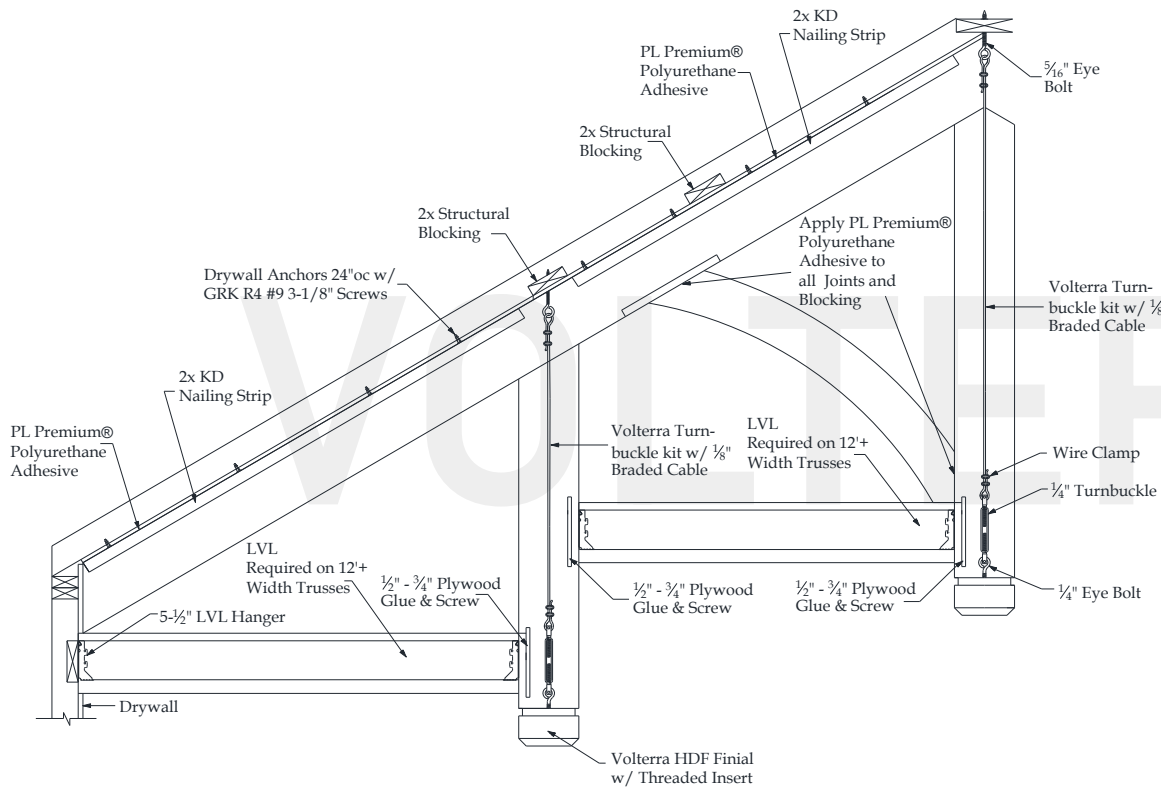

- A:** Layout beams and chalk lines to the inside of rafter beam.
- B:** Measure down ridge and screw in threaded eye bolts into structural blocking at all points.
- C:** Place KD nailing strip on chalk line and pre-drill  $\frac{1}{8}$ " holes 24" on center through strip and into drywall. Install drywall anchors into predrilled holes. Apply  $\frac{1}{4}$ " bead of PI adhesive to top of nailing strip and install using GRK R4 screws.
- E:** Glue and screw  $\frac{1}{2}$ " plywood nailing plate for web install.
- D:** Measure, cut and dry fit rafter beam then pull beam down. Apply PL adhesive to sides of nailing strips. Install rafter beam and use GRK 2- $\frac{1}{2}$ " Kameleon finish screws to secure 24" on center.
- E:** Cut 3"-4" diameter round hole for king & queen post turnbuckle.
- F:** Measure correct length and cut braided cable and install turnbuckle kit. Glue and screw off  $\frac{1}{2}$ " screw plate to inside of king, queen posts for connection of hammer and bottom chord. Stain raw foam on king & queen post and loose side. Install king & queen posts and their 4th side.
- G:** Glue and screw 2x blocks and  $\frac{1}{2}$ " plywood nailing plate for both wall posts (if applicable). Measure and cut both posts. Dry fit first. Apply PL adhesive to contact areas. Install using GRK Kameleon screws.
- H:** Install LVL hangers and LVL's (if applicable). Measure, cut and dry fit web and hammer beam, bottom chord and web. Glue and toe screw in place. Patch holes and touch up HDF if necessary.

Volterra Architectural Products LLC—1902 North 22nd Avenue -Phoenix, AZ 85009 - 602.258.7373

www.volterraproducts.com