

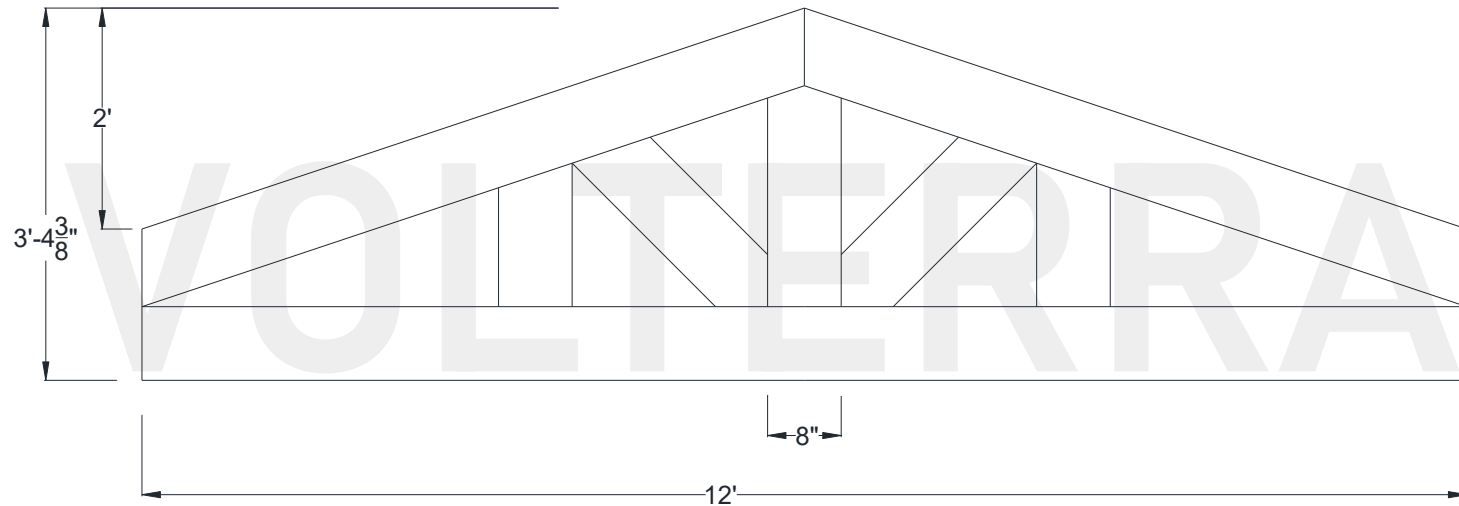

Sawtooth Hammered Truss

144" Width

Shown: 4/12 Pitch



Volterra Architectural Products LLC – 1902 North 22nd Avenue – Phoenix, AZ 85009 – 602.258.7373

www.volterraproducts.com

Sawtooth Hammered Truss

144" Width

Dimension Sheet

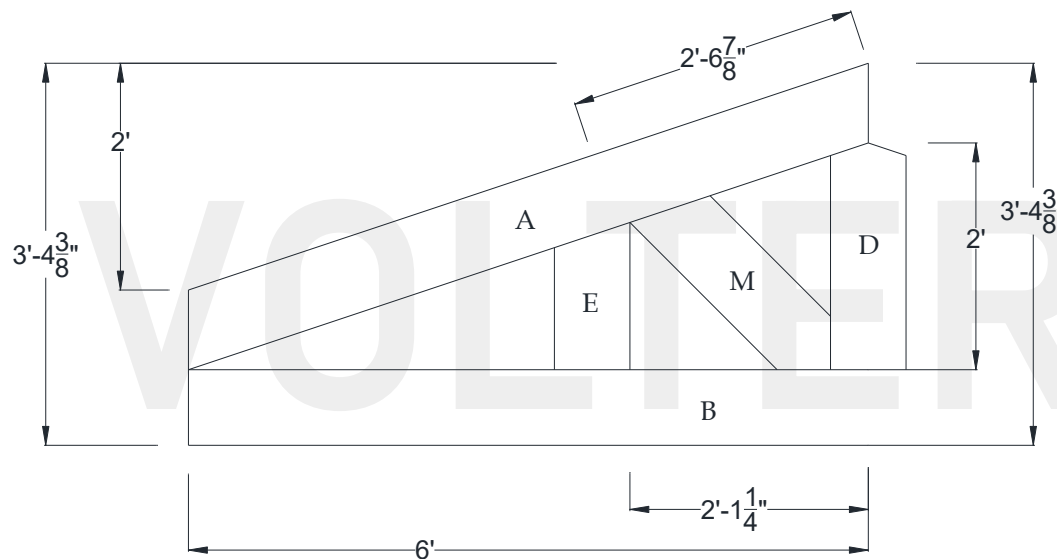

Specifications

Pitch:	4/12
A) Rafter/Top Chord:	8" x 8"
B) Bottom/Tie Chord:	8" x 8"
C) Upper/Tie Chord:	N/A
D) King Post:	8" x 8"
E) Queen Post:	8" x 8"
F) Jack Post:	N/A
G) Hammer Beam Top:	N/A
H) Hammer Beam Btm:	N/A
I) Collar Brace Upper:	N/A
J) Collar Brace Lower:	N/A
K) Hammer Brace:	N/A
L) Wall Post:	N/A
M) Web 1:	8" x 8"
N) Web 2:	N/A
O) Web 3:	N/A
P) Flying Buttress:	N/A
Q) Newel End:	N/A

Sawtooth Truss Recommended Interior Installation Procedures

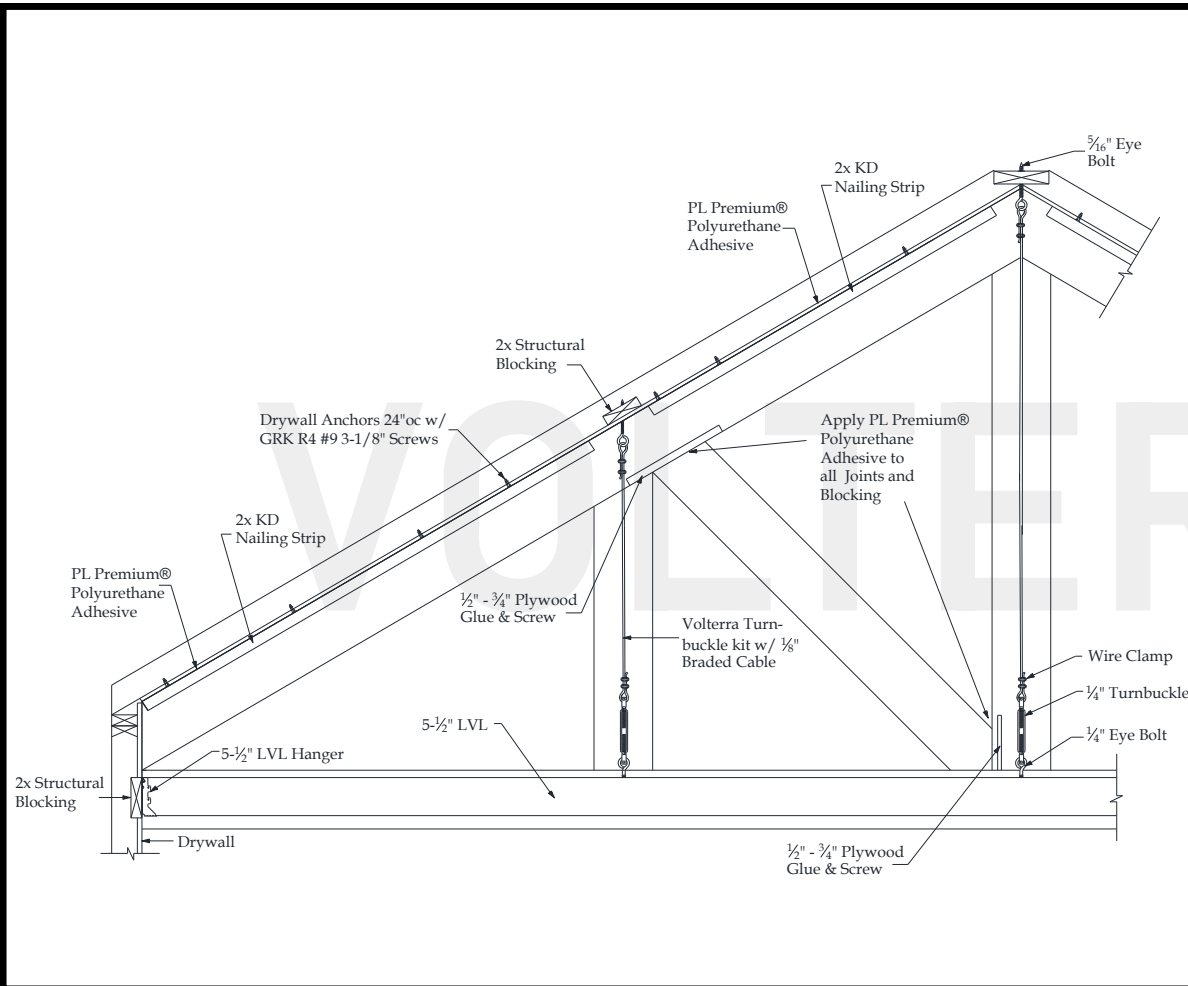

A: Layout beams and chalk lines to the inside of rafter beam.

B: Measure down ridge and screw eye bolts into structural blocking at all points.

C: Place KD nailing strip on chalk line and pre-drill $\frac{1}{8}$ " holes 24" on center through strip and into drywall. Install drywall anchors into predrilled holes. Apply $\frac{1}{4}$ " bead of PL adhesive to top of nailing strip and install using deck screws.

D: Glue and screw $\frac{1}{2}$ "- $\frac{3}{4}$ " plywood screw plate for web beam install to inside of rafter beam.

E: Measure, cut and dry fit rafter beam then pull beam down. Apply PL adhesive to sides of nailing strips. Install rafter beam and use finish screws to secure 24" on center.

F: Cut 3"-4" diameter round hole into the bottom of rafter beam for king/queen posts turnbuckle.

G: Measure correct length and cut braided cable and install turnbuckle kits and LVL hangers.

H: Add 2X blocking every 24" OC to LVL so bottom chord beam is a tight fit. Install LVL. Install bottom chord and its 4th side

I: Glue and screw off $\frac{1}{2}$ "- $\frac{3}{4}$ " plywood screw plate to inside of king post for connection of web. Stain raw foam on king/queen posts loose side. Install king/queen posts and their 4th side.

J: Measure, cut and dry fit web beam. Glue and toe screw in place. Patch holes and touch up HDF if necessary.